

BRITPART

The quality parts for Land Rovers



ACCESSORY CATALOGUE

4th
edition

4

www.britpart.com



BRITPART

The quality parts for Land Rovers

Welcome to Version 4 of the Britpart Accessory Catalogue. In addition to adding many more quality parts and accessories for Land Rover owners we've also given this edition a bit of a facelift - we hope you like the result and would welcome any comments.

At Britpart we are always adding new and exciting products to our accessories range, so remember to look at www.britpart.com for all the latest additions. Also worth remembering is that if there is no picture in the catalogue of a product in the catalogue, go to our website as there are plenty more product pictures there.

Exterior Protection	5 - 18
Side & Rear Steps	19 - 24
Racks & Luggage Boxes	25 - 30
Wheels	31 - 36
Lighting Equipment	37 - 42
Towing Equipment	43 - 48
Interior Protection	49 - 60
Seats & Trim	61 - 68
Off-Road Equipment	69 - 80
Winching Equipment	81 - 92
Performance Equipment	93 - 102
Suspension Equipment	103 - 114
Exhausts	115 - 118
Engines & Transmission	119 - 122
Repair & Service Parts	123 - 140
Service Kits & Filters	141 - 144
Vehicle Enhancements	145 - 156
Miscellaneous	157 - 166

ABOUT BRITPART



*innovation, quality
& style on demand*

Picture courtesy of Pascal Perrier

The Marque

Britpart is the leading independent wholesaler of parts and accessories for Land Rover vehicles, supplying in excess of 800 customers worldwide from government agencies to trade outlets.

The name 'Britpart' is synonymous with quality parts for Land Rovers and the company has earned a truly enviable reputation around the globe. For nearly 30 years, Land Rover enthusiasts the world over have come to identify Britpart as a brand to be trusted.

The Britpart logo has become a widely recognised and highly respected marque; it embodies excellence in the field, both in quality and commitment to meeting the needs of the customer.

Products

Britpart has always reacted swiftly to the demands of the parts market for all Land Rover vehicles, aiming to provide customers with exactly what they want, when they want it. Parts have long been the mainstay of Britpart's business, with many parts simply being unavailable from other sources; however, accessories are now becoming a major part of the business as owners of Land Rovers, old and new, are customising their vehicles to suit their individual tastes and lifestyles; everything they need is now available from Britpart.

The vast array of Britpart accessories ensures that no two Land Rovers are ever identical!

Land Rover appointed Britpart as an 'Approved European Parts Distributor' for all Land Rover Genuine Parts; this, together with Britpart's own vast range of parts and accessories, along with their extensive inventory of O.E.M. product, has resulted in Britpart becoming the ultimate 'One-Stop-Shop' providing everything its customers could possibly require, all ordered and delivered from one dedicated source.

Quality

Britpart is approved by Lloyd's Register Quality Assurance to BS EN ISO 9001:2000.

Britpart is renowned for quality parts at very competitive prices and takes pride in its excellent customer service, maintaining high stock levels with the aim of fulfilling orders promptly.

Distribution

Parts and accessories for Land Rover vehicles continually flow in and out of the massive state-of-the-art warehouse. Britpart's fleet of vans and trucks all sport the undeniably eye-catching Britpart blue and white livery. Between them they cover the length and breadth of the United Kingdom, including Northern Ireland, delivering directly to Britpart customers on a regular basis, adding to the personal touch that customers have come to associate with Britpart.

Service

Britpart has an enthusiastic and highly knowledgeable team so that you deal with people who have in-depth knowledge of the business. In addition to major government contracts, we successfully support individual parts retailers, supplying spares for Land Rover models old and new including Series, Defender, Range Rover, Discovery and Freelander.

The lively Sales operation boasts three highly trained teams; one each for Home Sales, European Sales and Export Sales with technical experts and sales advisors in each, eager to answer the telephone and organise despatch of goods to their customers within the shortest possible time.

Handmade

The highly skilled team in the Trim Shop make a wide range of seats, seat covers, bases, backs and benches etc for Land Rover vehicles by hand.

Equally skilled is the team in the Lock Shop where a wide range of light engineering work is carried out.

In keeping with the Britpart philosophy, all products leaving the Trim Shop and the Lock Shop are produced to the highest standards and meet with the strictest safety regulations.

Global

When Land Rover finally severed its association with Santana Motor SA it was Britpart who bought up all the existing stock from the factory in Spain and shipped it to their UK headquarters in Shropshire. The shipment included everything from small components to body panels and new engines, along with all the original drawings and tooling. Some of the stock was found to be interchangeable with Land Rover parts and a proportion of the rest is gradually making the journey back home with the assistance of our partner in Spain, Britpart España, Estanfi Automoción.

Britpart's other partners around the globe include: Britpart France, Britpart Belgium, Britpart Brazil, Britpart USA and Britpart Poland.

Britpart is seeking to further expand its comprehensive customer base overseas and is continually looking for well established independent stockists of Land Rover parts to work closely with.



Picture courtesy of Darren Whiley

Quality Parts

Britpart hold in excess of 16,000 stock items from o-rings and oil seals to engines and exhaust systems. Customers can choose from Britpart quality parts, O.E.M. products and Land Rover Genuine Parts; all delivered promptly at competitive prices.

Everything required for servicing, repairing, restoring or even rebuilding any Land Rover can be supplied by Britpart, thus enabling customers to order all they need on just one order sheet making it easy to keep track of stock and take delivery.

Quality Accessories

Britpart have all the latest accessories you need to customise your Land Rover; whatever the model, to look great on the road and work better off it! From wheels to roof racks, Britpart have everything to ensure that no two Land Rovers need ever look identical.



Certification No. 910885

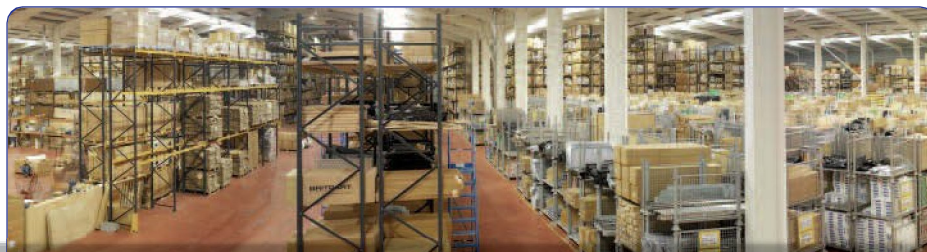

01

exterior protection

EXTERIOR PROTECTION

Going off-road?

Then here's where to find all the protection equipment your Land Rover will need from front to back and top to bottom.

Section contents -

A Bars	6
Bull/nudge bar	7
Bumper	7
Bumperettes	7
Chequer plate	8
Diff guards	9
Lamp guards	10 - 14
Mirrors & fittings	14
Mud flaps	15
Parking sensors	16
Radiator muffs	16
Rubbing strips	16
Steering/sump guards	17
Swivel housing gaiter kits	17
Transmission guard	17
Wheel arch kit - standard	18
Wheel arch kits - off-road	18

Through the jungle
Picture courtesy of Cyril Mischler

A BARS



LR005235

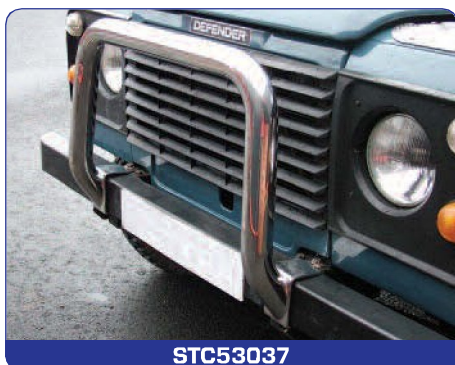

STC53037



STC50413



VUB501980

Add some front end protection to your vehicle with an A Bar - also a great addition if you'd like to add spot lights to your Land Rover!



LR005742



LR005237

IMPORTANT NOTICE
Please check local legislation before fitting a frontal protection device to a vehicle that is to be used on public roads.



STC53129



VUB501330



LR005239

Defender

LR005235	Defender - up to 2007	Black rubber	Includes spot lamp brackets
LR005742 NEW	Defender - 2007 onwards	Black rubber	Includes spot lamp brackets
STC53037	Defender - air con	Stainless steel	Includes spot lamp brackets

Discovery

LR005237	Discovery 3	Moulded black rubber	Includes spot lamp brackets
-----------------	-------------	----------------------	-----------------------------

Freelander

STC50413	Freelander	Preformed plastic & foam	No spot lamp brackets
STC53129	Freelander V6	Preformed plastic & foam	No spot lamp brackets
VUB501330	Freelander - from VIN4A00001	Moulded grey rubber	No spot lamp brackets

Range Rover

VUB501980	Range Rover Sport	Moulded grey plastic	Includes spot lamp brackets
LR005239 NEW	Range Rover L322	Moulded black plastic	Includes spot lamp brackets

BULL / NUDGE BAR



Picture courtesy of Daniel-Taw



VUB501270

Discovery 3

Flat

Note - Can only be supplied to non-EU countries

Serious front end protection for your Discovery 3!

BUMPER

DPB000270

Defender military front bumper

RRC6681

Centre pin for bumper

RRC6682

'R' Clip for centre pin

DA5626

Bumper kit - contains all the above

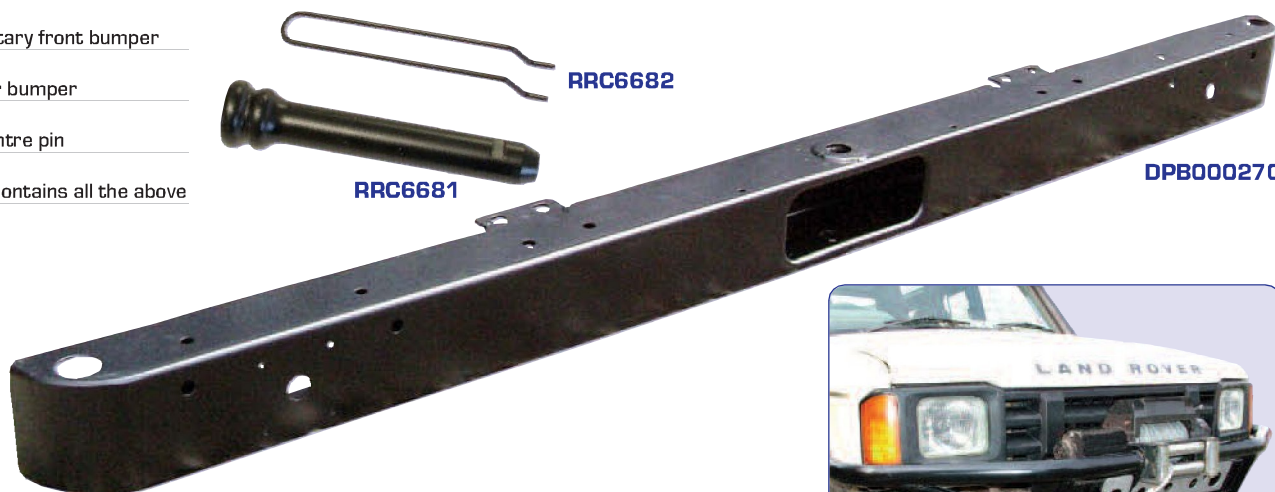

DPB000270



Winch Bumpers - see winching equipment section

BUMPERETTES



Added protection!

RTC4769



DA2071



RRC2970 / RRC2971

RTC4769 Series/Defender Front Single Galvanised

DA2071 Series/Defender Rear Pair Black

RRC2970 Series/Defender Rear Single - RHS Black
RRC2971 Series/Defender Rear Single - LHS Black

CHEQUER PLATE

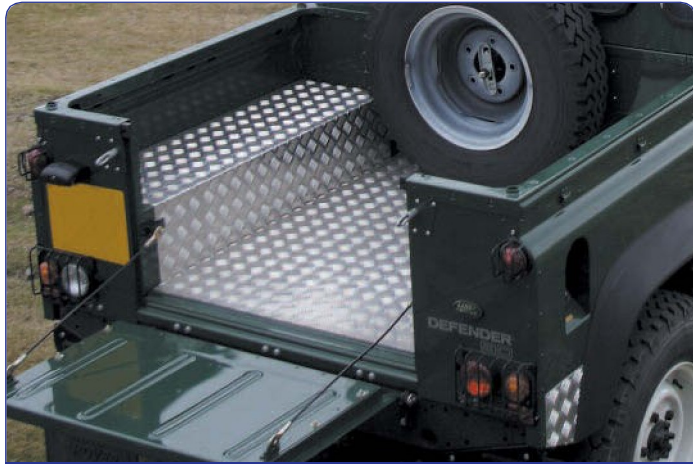

DA2070



DA4073 / DA4072



DA3080 / DA3078



DA3079

Series

DA2004	Wing top		Pair
DA2050	Rear cross member		Single
DA2051	Load bay liner	Short wheel base	Kit
DA2052	Sills	Short wheel base	Pair
DA2053	Sills	Long wheel base	Pair
DA2054	Bumper plate		Single
DA2067	Rear door	Without wiper	Single
DA4074	Rear wing	Short wheel base	Pair

Defender

DA2054	Bumper plate		Single
DA2062	Bumper tops		Pair
DA2060	Mud flap brackets		Pair
DA2061	Rear cross member		Single
DA2063	Rear floor - 110 County Station Wagon		Single
DA2064	Rear sides - 110 County Station Wagon		Pair
DA2066	Bonnet protector		Single
DA2067	Rear door	Without wiper	Single
DA2068	Rear door	Wiper - late	Single
DA2069	Rear door	Wiper - early	Single
DA2070	Load bay liner	90/Pickup/Hard top/County Station Wagon	Kit
DA4049	Wing top		Pair
DA4072	Sills	90	Pair
DA4073	Rear wing	90	Pair
DA4100	Sills	110	Pair
DA4071	Rear wing	110	Pair

Miscellaneous

DA2065	1,200mm x 2,500mm Chequer plate steel	Single
--------	---------------------------------------	--------

Britpart Chequer Plate - Defender

DA3078	Wing tops		Pair
	Natural aluminium finish		
DA3080	Bonnet protector	Defender 1983 - 2006	Single
	Natural aluminium finish		
DA4342	Bonnet protector	Defender 2007 - onwards	Kit
	Natural aluminium finish		
DA3079	Wing tops		Pair
	Satin black finish		
DA3081	Bonnet protector	Defender 1983 - 2006	Single
	Satin black finish		
DA4343	Bonnet protector	Defender 2007 - onwards	Kit
	Satin black finish		

Chequer Plate Kit - Defender

Kit contains - bonnet, wing, sill & rear corner protection

DA4296	90
DA4297	110



DA4296



DA2052



DA2060

Add some
heavy-duty
protection to
your Land Rover!

DIFF GUARDS - BOLT ON

Give your vehicle some extra protection with a diff guard. These guards are simple to fit (no drilling) and have the added advantage of having the fill plugs accessible at all times.

DA2250

Defender/Discovery
Bright galvanised finish

DA2250B

Defender/Discovery
Electroplate finish



DA2250



DA2250B



Picture courtesy of Cyril Mischler

LAMP GUARDS

Defender

DA1079 NEW	Defender	Rear	Wolf style - rectangular & round	Pair
DA4077	Defender	Front	Wolf style	Pair
DA4133	Defender Td5	Rear	Rectangular	Single
DA4134	Defender Td5	Rear	Round	Single
DA4349 NEW	Defender	Rear	Round ABS plastic tail light	Single
DA4400	Defender Td5 - 2003 on	Front & rear	Wolf style	Kit
RTC8860AA	Defender - to VIN 2A	Rear	1 Square & 1 L-shape	Pair
RTC8969	Defender - up to 2A622423	Front	Rectangular	Pair
STC8056	Defender 110 Hi Capacity	Rear	Rectangular	Pair
STC53157	Defender - from VIN 2A	Rear	1 Square & 1 L-shape	Pair
STC53158	Defender	Rear	Square hinged	Pair
STC53161	Defender - from 2A622424	Front	Rectangular	Pair
VUB504110	Defender 90 & 110	Rear	Round	Pair



DA1079



DA4077

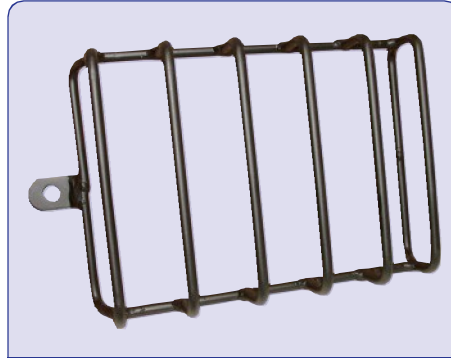

DA4133



DA4134



DA4349



DA4400

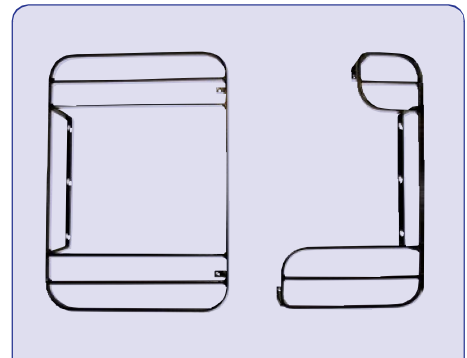

RTC8860AA

Protect those **valuable headlights** from accidental damage either on or off-road!

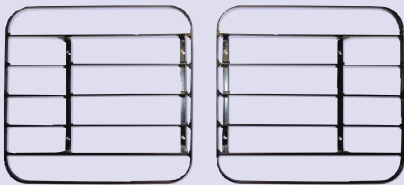

RTC8969



STC8056

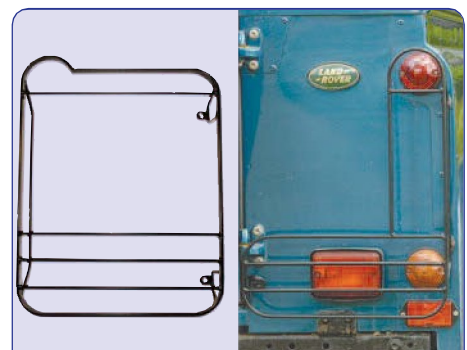

STC53157

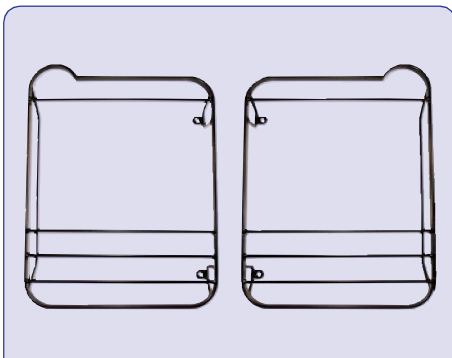

STC53158



STC53161

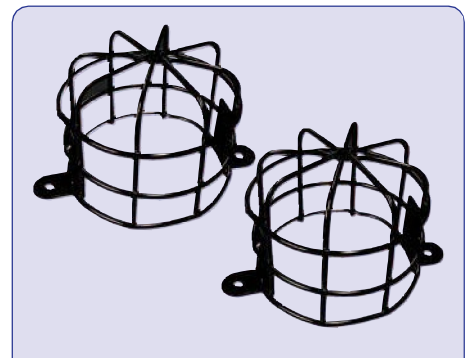

VUB504110

LAMP GUARDS - continued

Discovery

DA4130	Discovery 1 - to 1995	Front	Pair
DA4172	Discovery 1 300Tdi	Acrylic headlamp protectors	Pair
STC8452	Discovery 1 - 1995-1999	Front	Pair
STC8453	Discovery 1 - to 1999	Rear bumper - no drill	Pair
RTC9503AA	Discovery 1 - to 1999	Rear wing	Pair
STC50026	Discovery 2	Front - plastic	Pair
STC50027	Discovery 2	Rear bumper & rear upper set - plastic	Pair
STC50064	Discovery 2 - 1999 - 2002	Acrylic headlamp protectors	Pair
STC53181	Discovery 2 - from VIN 3A	Front	Pair
	Note - For fitment with nudge bar (STC53176)		
STC53193	Discovery 2 - 2003	Front	Pair
STC53194	Discovery 2	Rear wing	Pair
VUB500520	Discovery 2	Rear low	Pair
VUB501200	Discovery 3	Front (picture on next page)	Pair
VUB501380	Discovery 3	Rear (picture on next page)	Pair

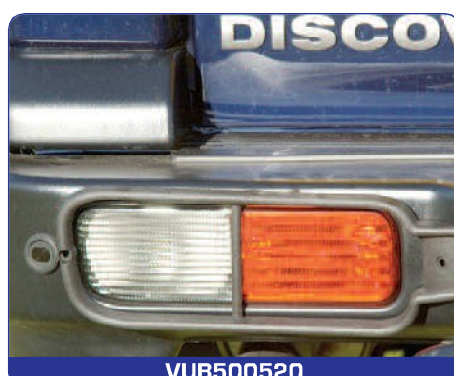

Need a dog guard?
See interior protection section!

LAMP GUARDS - continued



VUB501200



VUB501380

Freelander

STC7960	Freelander - to 2004	Rear kit - no drill	Set of 4
STC7962AA	Freelander - to 2004	Front	Pair
VUB501390	Freelander - 2004 on	Front	Pair
VUB501400	Freelander - 2004 on	Rear	Pair
LR002408	Freelander 2	Front	Pair
LR003685	Freelander 2	Rear	Pair



STC7960



STC7962AA



VUB501390



VUB501400



LR002408



LR003685



Picture courtesy of Pascal Perrier

LAMP GUARDS - continued

Range Rover

STC8026	Range Rover Classic	Front - hinged	Pair
STC8027	Range Rover Classic	Rear - hinged	Pair
STC8503AA	Range Rover P38	Front - drill fit	Pair
STC8504AB	Range Rover P38	Rear - drill fit	Pair
DA4173	Range Rover P38 - to 1999	Acrylic headlamp protectors	Pair
VUB001070	Range Rover L322 - pre 2006	Front	Pair
Note - Front lamp guards not compatible with wraparound protection bar			
VUB502610	Range Rover L322 - 2006	Front	Pair
VUB001080	Range Rover L322	Rear	Pair
VUB501930	Range Rover Sport	Front	Pair
VUB501920	Range Rover Sport	Rear	Pair



STC8026



STC8027



STC8503AA



STC8504AB



DA4173



VUB001070

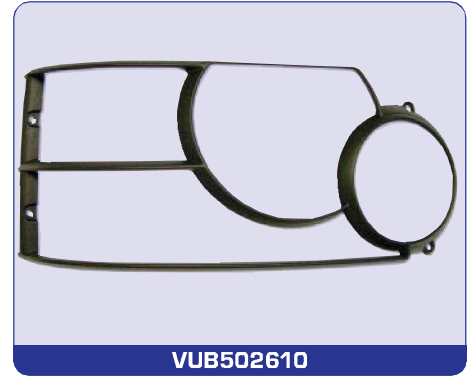

VUB502610



VUB001080



VUB501930



VUB501920



LAMP GUARDS - continued



345985



MRC316



345985P



MRC316

Series

345985	Series		Front
MRC316	Series		Rear
345985P	Series	Plastic coated	Front
MRC316P	Series	Plastic coated	Rear



MIRRORS & FITTINGS

Unbreakable Mirrors for Defenders

- > Optical quality polycarbonate lens - will not shatter like glass or discolour in sunlight
- > Strong, flexible polypropylene casing - will absorb hard blows without breaking
- > Universal - can be fitted to either left or right of vehicle
- > Lightweight - puts less strain on body fixings
- > Hard lacquer coating on lens - will repel condensation and surface water
- > Excellent reflectivity - superb daylight and night time vision



DA4405



DA4406

		Head Dimensions	Arm Length	
DA4404	Flat mirror	204 x 140mm (8 x 5 1/2")		Flat with fixing kit
DA4405	Flat mirror	204 x 140mm (8 x 5 1/2")	170mm	Flat with fixing kit and short arm
DA4406	Flat mirror	204 x 140mm (8 x 5 1/2")	290mm	Flat with fixing kit and long arm
DA4407	Convex mirror	204 x 140mm (8 x 5 1/2")		Convex with fixing kit
DA4408	Convex mirror	204 x 140mm (8 x 5 1/2")	170mm	Convex with fixing kit and short arm
DA4409	Convex mirror	204 x 140mm (8 x 5 1/2")	290mm	Convex with fixing kit and long arm

Mirrors & Fittings

DA2128	Series arm standard
DA2130	Series head 7 x 5"
DA2301	Series glass 7 x 5"
DA4034	Defender head 6 x 10 1/2"
MTC5083	Mirror arm - 90/110
MTC5084	Mirror head - 90/110
MTC5217	Assembly - 90/110
RRC8443	Arm 11 1/2" long

Good visibility is imperative on today's highways and byways so these new high impact resistant mirror heads are essential stock items.



MTC5217

MUD FLAPS



CAT500540PMA



DA4531

Britpart Branded Defender Rear Mudflaps

CAT500410PMA	RHS - universal fitment	Black logo	Single
CAT500450PMA	LHS - no exhaust cut-out	Black logo	Single
CAT500540PMA	LHS - exhaust cut-out	Black logo	Single
DA4531	90 - exhaust cut-out	Yellow logo	Pair
DA4532	90 - no exhaust cut-out	Yellow logo	Pair

Other Mudflaps

RTC9479	Defender 90 & 110 - from 2007	Front	Pair
RTC6820	Discovery 1 - kit	Front	Pair
RTC6821	Discovery 1 - kit	Rear	Pair
CAS500010PCL	Discovery 3	Front	Pair
CAT500010PCL	Discovery 3	Rear	Pair
LR003324	Freelander 2	Front	Pair
LR003322	Freelander 2	Rear	Pair
CAS000150PMA	Range Rover L322 - up to VIN 5A9999999	Front	Pair
CAT000180PMA	Range Rover L322 - up to VIN 5A9999999	Rear	Pair
CAS500060PMA	Range Rover L322 - from VIN 6A198416	Front	Pair
CAT500070PMA	Range Rover L322 - from VIN 6A198416	Rear	Pair
CAS500070PCL	Range Rover Sport	Front	Pair
CAT500120PCL	Range Rover Sport	Rear	Pair



DA4532

Reduce those muddy splashes from over your Land Rover



RTC6821



CAS500010PCL



CAT500010PCL



LR003324



CAT500070PMA



CAS500070PCL

PARKING SENSORS

These bumper* mounted sensors will detect the distance between your vehicle and any rear obstruction and warn the driver to any potential obstructions.

Add an extra set of 'eyes' when reversing...

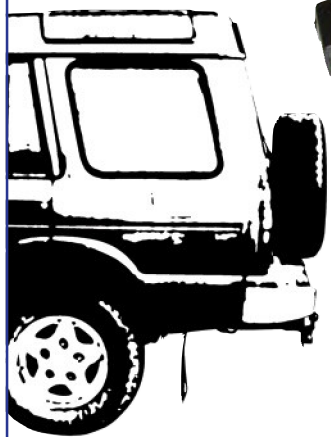

DA4510

- DA4510**
Three stage alarm sound warning system
Kit contents include -
- > 4 x Bumper fit sensors
 - > 1 x Warning buzzer
 - > 1 x Control unit
 - > 1 x Wiring harness
 - > 1 x Cutting tool
 - > 1 x Fitting accessories
 - > 1 x Installation instructions



DA4511

- DA4511**
Three stage alarm sound warning system with LED display
Kit contents include -
- > 4 x Bumper fit sensors
 - > 1 x Warning buzzer and LED display
 - > 1 x Control unit
 - > 1 x Wiring harness
 - > 1 x Cutting tool
 - > 1 x Fitting accessories
 - > 1 x Installation instructions

*Note - sensors do not work with metal bumpers

RADIATOR MUFFS



DA4025BLACK



DA2160BLACK



DA2161BLACK

Series 2

DA4025BLACK	Black edging
DA4025BLUE	Blue edging
DA4025BROWN	Brown edging
DA4025GREEN	Green edging

Series 3

DA2160BLACK	Black edging
DA2160BLUE	Blue edging
DA2160BROWN	Brown edging
DA2160GREEN	Green edging

Defender

DA2161BLACK	Black edging
DA2161BLUE	Blue edging
DA2161BROWN	Brown edging
DA2161GREEN	Green edging

Note - The radiator muffs are black with either black, blue, brown or green coloured edging.

Control the flow of air into your radiator with a quality British made radiator muff!

RUBBING STRIPS

Protect your bodywork from dents and scrapes with a smart set of 4 solid and durable bodyside moulding strips.

DGJ500140PMA	Range Rover L322
DGJ500020PCL	Range Rover Sport



DGJ500140PMA

STEERING / SUMP GUARDS



DA2228



DA5507



DA5507LHD

DA2228	Defender - 1985 onwards	Galvanised steel	RHD & LHD
DA5507	Defender - 1985 onwards	Aluminium	RHD
DA5507LHD	Defender - 1985 onwards	Aluminium	LHD
DA5508	Discovery 1/Range Rover Classic	Aluminium	RHD & LHD



DA5508

Added **protection** from those hidden dangers when off-roading!

SWIVEL HOUSING GAITER KITS

- > Bond in place under existing flange
- > Completely seals against dust, water and grit
- > Moulded in high performance neoprene rubber
- > Kit includes two gaiters, metal straps, bonding agent, gloves and full instructions
- > No special tools required
- > Proven tongue and groove for easy assembly
- > Two year guarantee

DA3056	Series
DA3057	Defender/Discovery/Range Rover Classic
DA3057GLUE NEW	Additional bonding agent for DA3057

> For easier fitment of gaiter without dismantling the axle assembly

Permanent **protection** for swivels, spheres and joints!



DA3056 / DA3057

TRANSMISSION GUARD

DA5625
Reduce damage to your Defender 90. Made from galvanised steel, this transmission guard protects your 90's gear box and cross members from snagging and reduces damage to your vehicle. Bolts on and is easy to fit and importantly it is also easy to remove when your vehicle needs servicing. Fits pre-Td5 or can be fitted to Td5 with centre exhaust removed and pipe fitted.



DA5625

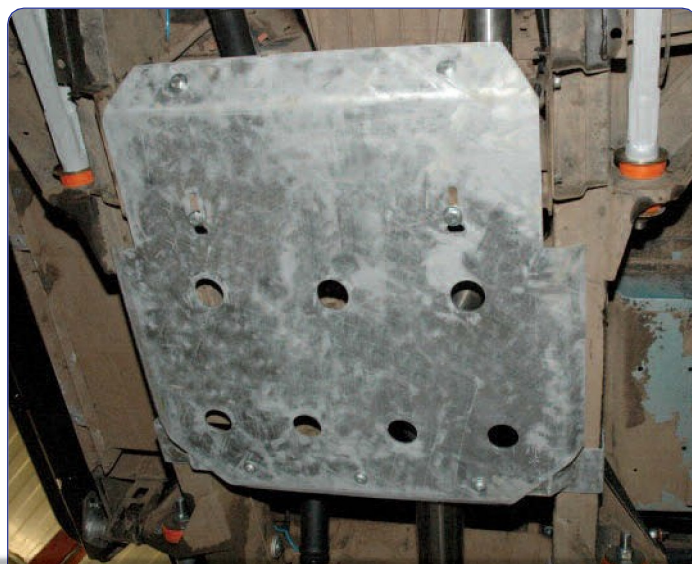

WHEEL ARCH KIT - STANDARD



DA1059

Defender eyebrow kit
 > 4 eyebrows and rivets

WHEEL ARCH KITS - OFF-ROAD



DA2366



DA2364	Discovery 1/Range Rover Classic	3-door
DA2365	Discovery 1/Range Rover Classic	5-door
DA2366	Defender	

Suitable for Defender 90 from 1984 to present and from 90 to 130 wheelbase and Hi-Cabs. 2" wider than standard enabling tyres up to 14" wide and/or wheel spacers to be fitted while being legal for MOT testing. Made from an unbreakable plastic - ideal for extreme off-road use.

DA1960	Discovery 2	50mm
DA1961	Discovery 2	75mm

These two Discovery 2 wheel arches enable larger tyres to be fitted while still being legal as these arches cover the tyres when wider tyres are fitted. The 50mm ones are required for large off set wheels while the 75mm arches will cover the tyres when wheel spacers are used. They are virtually indestructible and all fixings are supplied with the kit. Up to 35" diameter tyres are ok with a 2" lift and these arches as just over 40mm is cut out of the wings when fitting them.



Picture courtesy of Guy Stryckmans

02

side & rear steps

SIDE & REAR STEPS



Add some smart new steps to your Land Rover for assistance with getting in and out.

Section contents -

Defender	20
Discovery	21
Freelander	22
Range Rover	23

SIDE & REAR STEPS - DEFENDER



STOP PRESS... See page 174
 These side steps are available in a stainless steel finish without chequer plate - **DA7012SS**

DA7012

DA7012
 90 - all models Side steps - pair
 Black with chequer plate

DA7012SS NEW
 90 - all models Side steps - pair
 Stainless steel

DA7011
 110 - all models Side steps - pair
 Black with chequer plate

DA7011SS NEW
 110 - all models Side steps - pair
 Stainless steel

DA4101
 90 - all models Side steps - pair
 Rubber top

DA4060
 110 - all models Side steps - pair
 Rubber top

DA4070
 Rear tow ballstep - double
 Zinc plated

DA4070B
 Rear tow ballstep - double
 Black

STC50269AA
 90 from XA onwards Rear step - includes
 regulation tow bracket

STC50301
 110 from XA onwards Rear step - includes
 regulation tow bracket

STC7631
 Side step - folding

STC7632
 Rear door step - folding



STOP PRESS... See page 174
 These side steps are available in a stainless steel finish without chequer plate - **DA7011SS**

DA7011

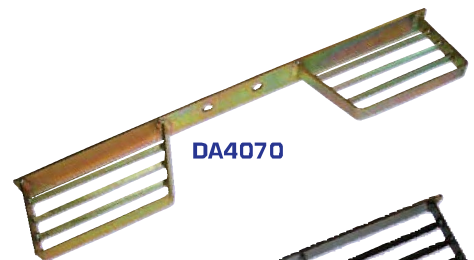

DA4070

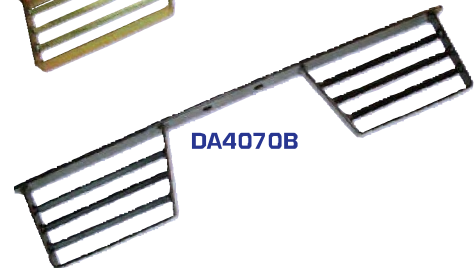

DA4070B



STC7631



DA4101

DA4060

STC50269AA



STC7632

SIDE & REAR STEPS - DISCOVERY



STC8130AB

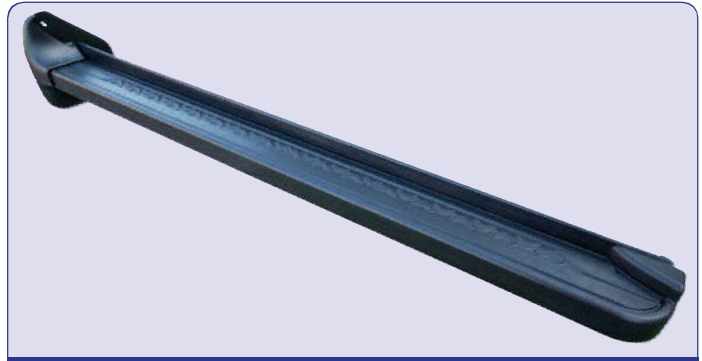

DA4258



STC50030

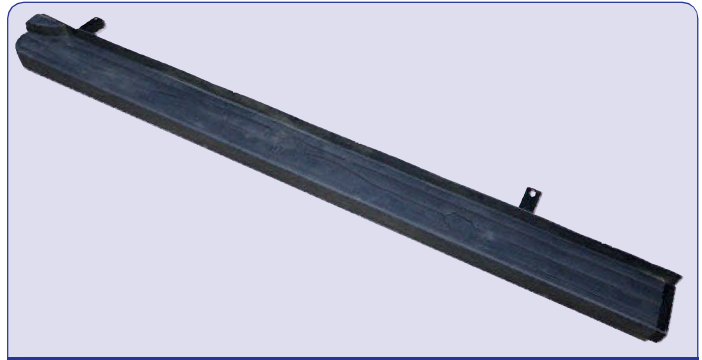

STC50031

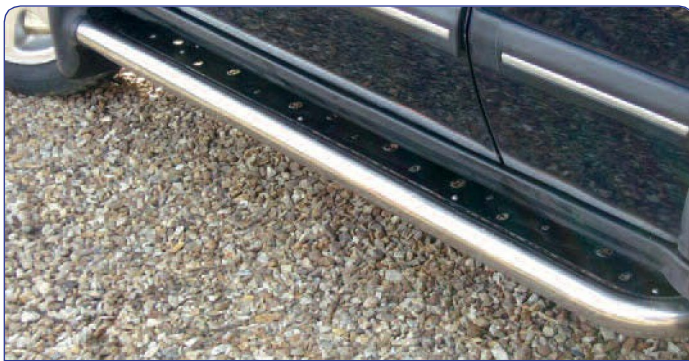

STC50032

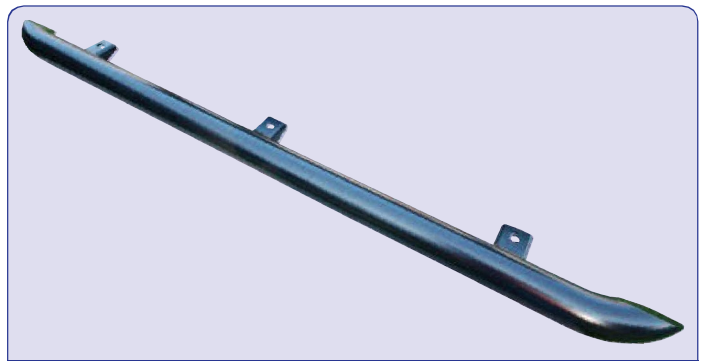

VTD500010



VTD500020



VTK500010 / VPLAP0035

RTC9505AC	Discovery 1	Rear retractable step		
RTC9593AA	Discovery 1	Spare shock absorber for rear retractable step (RTC9505AC)		
STC8130AB	Discovery 1	Side steps	Chevron tread	Pair
DA4258	Discovery 2	Side steps - including mudflaps	Black rubber	Pair
KVL100040	Discovery 2	Spare shock absorber for rear retractable step		
STC50030	Discovery 2	Side steps - including mudflaps	Chevron tread	Pair
STC50031	Discovery 2	Side steps - including mudflaps	Oasis tread	Pair
STC50032	Discovery 2	Side steps - including mudflaps	Stainless steel	Pair
VTD500010	Discovery 3	Black steel side protection tubes		Pair
VTD500020	Discovery 3	Stainless steel side protection tubes		Pair
VTK500010	Discovery 3	Side steps		Pair
VPLAP0035		With polypropylene side step top and a brushed aluminium side trim		



RTC9505AC

Britpart have a wide range of steps to suit your vehicle

SIDE STEPS - FREELANDER

STC53077

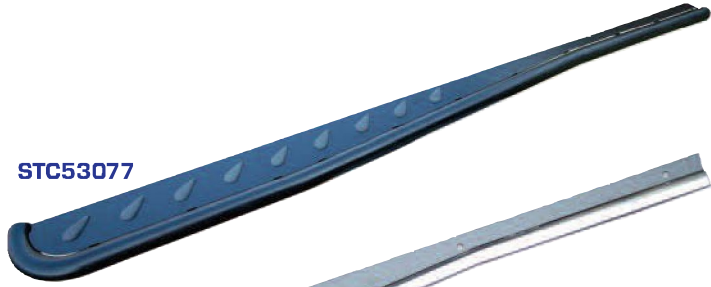

STC53078



LR002773



LR003318



LR003840

STC53077	Freelander - from 2002 onwards		
	Side steps	Black	Pair
STC53078	Freelander - from VIN2A000001		
	Side steps	Stainless steel	Pair
LR002773	Freelander 2		
	Side steps		Pair
	With thermo plastic elastomer side step top and a brushed aluminium side trim		
LR003318	Freelander 2		
	Side protection tubes	Stainless steel	Pair
LR003840	Freelander 2		
	Side protection tubes	Black	Pair



SIDE STEPS - RANGE ROVER

STC8130AB

Range Rover Classic Pair
Side steps - black rubber

STC8505AA

Range Rover P38 Pair
Side steps Oasis pattern
Not including mudflaps - front STC8535

VUB001230

Range Rover L322 Pair
Stainless steel side protection tubes

VUB002510

Range Rover L322 Pair
Black steel side protection tubes

Note - Both above tubes can be fitted with or without front mudflaps

VUB503660

Range Rover L322 Pair
Side steps including front mudflaps with EPDM (synthetic rubber) top and hard plastic trimming

VUB001300

Range Rover L322
Side step replacement insert moulding for VUB503660

Right hand side Single

VUB001310

Range Rover L322
Side step replacement insert moulding for VUB503660

Left hand side Single

VTK500020

Range Rover Sport Pair
Side steps

With thermo plastic elastomer side step top and a brushed aluminium side trim



STC8505AA



VUB001230



VUB002510



VUB503660



VTK500020



STC8130AB





Picture courtesy of John Stewart

03

racks & luggage boxes
RACKS & LUGGAGE BOXES

Got a load to carry?
We've got racks and
luggage boxes to suit all
Land Rovers and all loads.

Section contents -

Bike racks	26
Ladders	26
Roof racks - galvanised flat pack kits	27
Roof racks & bars	28
Roof racks & boxes - Mont Blanc	29
Roof racks & boxes - Thule	30

Haast Beach, New Zealand
Picture courtesy of John Brunsdn

BIKE RACKS



DA4118



DA4119



DA4121



STC7929



STC50063

These bike racks mount to the spare wheel carrier and are easy to fit.

DA4118	Discovery 1	4 Bike
DA4119	Discovery 2	4 Bike
DA4121	Freelander	3 Bike
STC7929	Freelander 1/Freelander 2	2 Bike
STC50063	Discovery 2/Discovery 3 & Range Rover Sport	2 Bike

LADDERS



DA3073



STC50417



DA3071



STC50134



DA3073B

AGP780020

DA1089	Defender - 90/110	Galvanised
(see picture in next section)		
DA3073	Defender - 90/110	Grey
DA3073B NEW	Defender - 90/110	Black
STC50417	Defender - 90/110	Black
DA3071	Discovery 1 & 2	Black
STC50134 NEW	Discovery 2	Black
AGP780020 NEW	Discovery 3/Discovery 4	Black

ROOF RACKS - GALVANISED FLAT PACK KITS



DA1089



DA1091



DA1093

DA1090	Flat floor
DA1091	Contour floor
DA1092	Contour floor
DA1093	Flat floor
DA1089	Ladder

For above kits Ladder
Note - Contour racks must **NOT** be used on vehicles fitted with a sunroof.

Note -
 SWB flat packed roof racks - length 1,990mm (78^{1/2}""); height 420mm (16^{1/2}""); width 120mm (5"); weight 25kgs
 LWB flat packed roof racks - length 2,800mm (110^{1/2}""); height 420mm (16^{1/2}""); width 120mm (5"); weight 30.5kgs



Picture courtesy of Darren Whiley

ROOF RACKS & BARS **NEW**

DA3072

DA3070

DA3075

DA3077

- > All aluminium construction, fully welded
- > Powder coated finish
- > Patented slat, with groves to accommodate 8mm bolt head
- > Modular design - allow accessories to be mounted and removed as need without drilling
- > Rail towards the rear, open in the front
- > Gutter mount stainless steel clamps

DA3072	Defender 90	Full rack	Black
DA3070	Defender 110	Full rack	Black
DA3075	Discovery 1 & 2	Short rack	Silver
DA3077	Freelander 1	Full rack	Silver
DA3086	Freelander 1	Full rack - original mountings	Silver

Defender **NEW**

LR004101	90	Roof rack	1,600mm
LR004100	110	Roof rack	2,400mm
LR004102	110/130 Crew cab	Roof rack	
STC7582		Roof bars	Sports

Discovery **NEW**

RTC9539AB	Discovery 1	Roof rack	Standard
STC8057AC	Discovery 2	Roof bars	Sports
LR006848	Discovery 3 & 4	Roof rack luggage carrier	Use in conjunction with roof cross bars
CAB500021PMA	Discovery 3 & 4	Roof rack assembly - luggage	
VPLAR0001	Discovery 3 & 4	Roof rack cross bars	
LR006849	Discovery 3 & 4	Roof ski carrier	Use in conjunction with roof cross bars

Freelander **NEW**

STC7932	Freelander 1 - 5-door	Roof rack cross bars	
STC50327AA	Freelander 1 - 3-door	Roof rack cross bars	
STC50433	Freelander 1	Roof rack	Expedition
LR006848	Freelander 2	Roof rack luggage carrier	Use in conjunction with roof cross bars
LR002417	Freelander 2	Roof rack cross bars	
LR006849	Freelander 2	Roof ski carrier	

Range Rover **NEW**

STC50176AA	Range Rover Classic	Luggage cross bars	
LR006848	Range Rover Classic	Roof rack luggage carrier	Use in conjunction with luggage cross bars
STC50252	Range Rover P38	Roof cross bars	Sports
STC8506	Range Rover P38	Roof rails	Side
LR006849	Range Rover P38	Roof ski carrier	
CAB500070PMA	Range Rover L322	Roof rack luggage carrier	Expedition
CAB000040PMA	Range Rover L322	Roof rack cross bars & rails	
LR006848	Range Rover L322	Roof rack luggage carrier	Use in conjunction with roof cross bars
VUB502790	Range Rover L322	Roof bars - fixed	Sports
LR006849	Range Rover L322	Roof ski carrier	Use in conjunction with roof cross bars
CAB500130PMA	Range Rover Sport	Roof rack luggage carrier	Expedition
LR006848	Range Rover Sport	Roof rack luggage carrier	Use in conjunction with roof cross bars and rails
VUB502130	Range Rover Sport	Roof rack cross bars and rails	
LR006849	Range Rover Sport	Roof ski carrier	

ROOF RACKS & BOXES - MONT BLANC

Roof Boxes

DA4331	Vista 380	Half width	
380 litres	2,000 x 650 x 450mm (LxWxH)		Weight: 15kg
DA4332	Vista 540	Full width	
540 litres	2,000 x 950 x 420mm (LxWxH)		Weight: 17kg

- > Secure-Assure - keys cannot be removed until locks securely engaged
- > 2 or 3 point central lock system
- > Lock up struts - new improved design with side opening for ease of loading
- > 80mm width fixings to suit most roof bar sizes
- > UV resistant, high impact ABS
- > Load securing straps included

DA4333	Triton 450	430 litres	2,240 x 940 x 430mm (LxWxH)
DA4334	Triton 650	620 litres	1,970 x 830 x 380mm (LxWxH)

- > Premium roof box range with modern design for all kind of activities
- > Made of UV-resistant ABS plastic with gas struts for soft opening and closing of box
- > Three point central locking
- > Load securing straps included
- > Flexible attachment to the load bar
- > Unique quick attachments - the box is attached from the inside
- > Fits both square bars and aluminium bars with C-slots



DA4332



DA4333

Roof Bars & Rails

DA2312	Discovery 1	System 400 - Standard
DA2310	Freelander 1	System 400 - Standard
DA4313	Range Rover P38	System 400 - Standard

- > Easy to fit, good value load carrier system with fully galvanised roof bars

MONT BLANC®



SYSTEM 400 - STANDARD

DA4312	Discovery 3	System 3000 - Premium
DA4311	Freelander 1	System 3000 - Premium
DA2311	Defender	System 3000 - Premium
DA2315	Range Rover P38	System 3000 - Premium
DA4314	Range Rover Sport	System 3000 - Premium
DA4319	Range Rover L322	System 3000 - Premium

- > Premium roof bar system with quick fit and release feature and integrated lock system (excluding gutter fit) with max load range 75-100kg
- > Manufactured to DIN standard 75302/15011154



SYSTEM 3000 - PREMIUM



DA4315

DA4316

DA4317

Rails not included

DA4318

Carriers

- DA4315** Discovery - cycle carrier
- Roof mounted with stylish aluminium profile • Wheels fit into moulded profile which holds the cycle upright leaving both hands free to secure the frame and wheels • Locking the cycle into frame holder secures carrier to load carrier • Black-painted frame holder tube in special steel • Base unit made of aluminium and UV-resistant composite material • Takes frame diameters from 20 up to 80mm • Max. tyre width 2.2 inches • Manufactured in accordance with DIN75302 • Will fit to both standard and aluminium bars • Weight: 4.2 kg
- DA4316** Scott - cycle carrier
- Stable easy-to-use roof mounted cycle holder • Frame holder with quick attachment for easy fitting without tools • Takes frame diameters from 25 up to 80mm • Wheels rest in adjustable wheel holders and are fastened with strong securing straps • Lockable to roof rack as well as bicycle • Can be fitted on all standard load bars and aluminium profiles.
- DA4317** Barracuda - cycle carrier
- Wheels locate in a moulded profile, which holds the cycle in an upright position - you can use both hands when securing the wheels and the frame
 - When the cycle is attached to the frame holder, the cycle holder is secured to the load carrier • Cycle is secured in the frame holder • Chromium-plated frame holder tube in special steel • Base unit made of UV-resistant composite material • Takes frame diameters from 20 up to 80mm • Max tyre width 2.2 inches • Manufactured in accordance with DIN 75302 • Max weight capacity 17kg
- DA4318** Tahiti 6 - surfboard and canoe carrier
- Stable and gentle holder for surfboards, canoes, kayaks, etc. • Holder comes complete with cradles, straps and a holder for a mast or paddle
 - Rubber-covered cradles are kind to the hull and allow the boat/surfboard to lie steadily during transport

ROOF RACKS & BOXES - THULE

Roof Boxes

DA4321 X1 450 litres
 1,900 x 900 x 380 (LxWxH) Load capacity 75kg Weight 23kg

- > Rugged design for those who want to stand out from the crowd
- > Quick-Snap mounting system, for easy fitting of the box
- > Dual-Side opening for convenient mounting, loading and unloading
- > Central safety locking system
- > Unique and spacious design in special tech silver colour



DA4321

DA4322 Atlantis 600 340 litres
 1,900 x 630 x 410 (LxWxH) Load capacity 75kg Weight 16kg

- > Spacious roof boxes featuring exciting design and smart functions
- > Patented Power-Grip quick mount system, for fast and secure fitting using one hand
- > Aerodynamic design for great stability, reduced air resistance, wind noise and vibrations
- > Dual-Side opening for convenient mounting, loading and unloading
- > Central safety locking system with grip-friendly key



DA4326

THULE[®]
 SWEDEN
CAR RACK SYSTEMS



DA4322

Roof Bars

DA2990	Discovery 1	Roof bars
DA2991	Discovery 2 (with modified trim)	Roof bars
DA4323	Discovery 2	Roof bars
DA4325	Discovery 3 - (T Profile)	Roof bars
DA4324	Discovery 3	Roof bars
DA4328	Freelander 1 1998-2003 3-door and 5-door	Roof bars
DA4329	Freelander 1	Roof bars
DA4326	Freelander 2 - mounts to gutter	Roof bars & rails
DA4327	Freelander 2	Roof bars
DA3002	Range Rover Classic	Roof bars
DA2993	Range Rover P38	Roof bars
DA2996	Range Rover Sport	Roof bars



DA4327



DA4329



DA4323



DA2996



Carrier

STC7969 Cycle carrier

- > The smartest, most elegant solution for loading and transporting a bike on the roof
- > The self-adjusting and upright frame holder into which the bike automatically slides, makes bike loading easy
- > Adjusting and securing is done comfortably and quickly, with a turning knob, at roof height
- > Quick-release straps, adjustable for different wheel sizes, hold the wheels securely in place
- > Light and convenient aluminium design
- > Can easily be fitted on either side of the car roof
- > Lockable - bike to bike carrier, bike carrier to load carrier
- > Best in test
- > Fits frame dimensions up to 100mm



STC7969

Freshen up your Land Rover with a new set of wheels, then secure them with a set of locking wheel nuts.

Section contents -

Inner tube	32
Locking wheel nuts, keys & caps	32
Spare wheel carriers	33
Spare wheel covers	33
Tyre pressure monitoring system	34
Tyre repair kit & air compressors	33
Wheel spacers & adaptor kits	34
Wheel wrenches	34
Wheels	35
Zu rims	36



INNER TUBE



DA3000

DA3000 750 x 16



LOCKING WHEEL NUTS, KEYS & CAPS



STC3420



KBM100450



STC3415



RRB100510



RRB500100



RTC9535



STC3582



STC3601



STC7623



STC8513



STC50080



STC8843AA

Locking wheel nut keys for Defender/Discovery 1/Discovery 2/Range Rover P38

Code A	STC3420
Code B	STC3421
Code C	STC3422
Code D	STC3423
Code E	STC3424
Code F	STC3425
Code G	STC3426
Code H	STC3427
Code I	STC3428
Code J	STC3429

Protect your valuable wheels and tyres from theft!

Locking wheel nuts and keys for Freelander to 2006

	Locking wheel nut	Locking wheel nut key
Code A	RRD100520	KBM100450
Code B	RRD100530	KBM100460
Code C	RRD100540	KBM100470
Code D	RRD100550	KBM100480
Code E	RRD100560	KBM100490
Code F	RRD100570	KBM100500
Code G	RRD100580	KBM100510
Code H	RRD100590	KBM100520
Code I	RRD100600	KBM100530
Code J	RRD100610	KBM100540

Locking wheel nuts keys for Defender 1987-2006 & 2006 -/Discovery 1

Code F	STC3415
Code H	STC3417

ANR6094L	Freelander locking wheel nut cap
KBP10001	Universal nut cover removal tool
RRB100510	Discovery 2 with alloy wheels
Kit contains -	1 x nut; 1 x key; 1 x cover; 1 x removal tool
RRB500100	Discovery 3/Range Rover L322/Range Rover Sport
Kit contains -	4 x nuts; 1 x key
RRD000100	Range Rover L322 - Locking wheel nut - 35
RRD000110	Range Rover L322 - Locking wheel nut - 36
RRD000120	Range Rover L322 - Locking wheel nut - 37
RRD000130	Range Rover L322 - Locking wheel nut - 38
RRJ000030	Range Rover L322 - Wheel nut cap
RTC9535	Range Rover Classic 1989 to 1994/Defender/Discovery 1 with steel wheels
Kit contains -	5 x nuts; 1 x key (black finish)
STC3582	Discovery 2/Range Rover P38
Locking wheel nut key - code C	
STC3601	Defender/Discovery 1 with alloy wheels
Kit contains -	5 x nuts; 1 x key; 1 x black bag for key
STC7623	Defender with deep dish alloy wheels
Kit contains -	5 x nuts; 2 x keys
STC8513	Range Rover P38A with alloy wheels
Kit contains -	4 x nuts; 1 x key
STC50080	Discovery 2 - Full set of wheel nuts
Kit contains -	4 x locking nuts; 4 x spare caps; 18 x normal nuts (inc. caps); 1 x key; 1 x remover tool
STC8843AA	Range Rover Classic 1989 to 1994/Defender/Discovery 1 with alloy wheels (not deep dish wheels)
Kit contains -	5 x nuts; 1 x key

SPARE WHEEL CARRIERS



DA2232

DA2232 NEW
Defender/Series
Swing away rear door mount



DA2259

DA2259 NEW
Defender 2002 - 2007
Swing away rear door mount

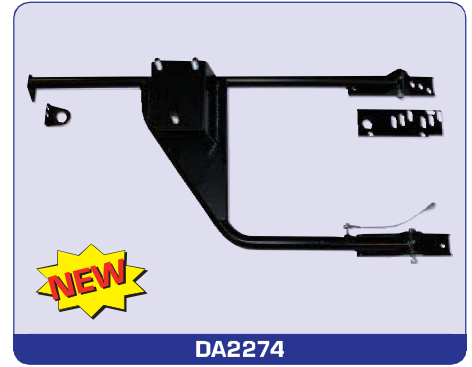

DA2274

DA2274 NEW
Defender with half door tailgate
Swing away rear door mount

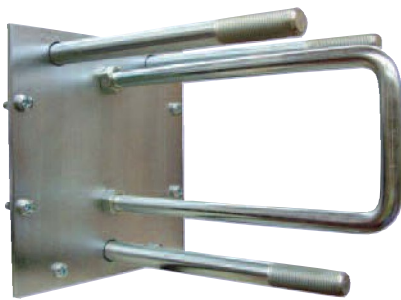

DA2215

DA2215
Defender/Series
Fixed rear door mount

SPARE WHEEL COVERS

DA2021	750 x 16	Plain black
DA2022	600 x 16	Plain black
DA2026	205 x 16	Plain black



DA2026

TYRE REPAIR KIT & AIR COMPRESSORS

Don't get caught out with a flat tyre or two!

*Pack and leave an easy to use Britpart tyre repair kit in your vehicle.**

DA2390 - Tyre repair kit in travel case

How It Works

1. Find and remove the item that caused the puncture.
2. Apply rubber solution to the reamer tool then push the reamer into the puncture and work up and down until the reamer moves easily in the hole.
3. Thread one rubber tyre plug in the hook tool.
4. Push the rubber tyre plug into the hole until 1/2" of the tyre plug remains outside the tyre then turn the hook tool a quarter turn and pull out slowly.
5. Cut off the excess tyre plug as close to the tyre as possible.
6. If the puncture is too big have the tyre fixed by a professional.

**Recommended for off-road use only.*



DA2390



It's no good being able to repair your tyre if you can't inflate it!

- DA2392** Double-pump air compressor
> Air flow - 150ltr/min
- DA2354** Single-pump air compressor
> Air flow - 72ltr/min

See the off-road section for more details on the portable air compressors from Britpart.



DA2392



DA2354

TYRE PRESSURE MONITORING SYSTEM



Are your tyres at the right pressure?

DA4512

This system is an advanced monitoring & alert system of tyre conditions. It monitors tyre pressure and temperature then relays the state of each tyre to a display unit. When any abnormalities are detected, the system will display the status of the affected tyre and sound an alarm to ensure you take action to remedy the problem. Keeping your tyres in good condition at the right pressure can extend the life of your tyres, reduce fuel consumption and improve handling.

Tyres that are at the right pressure will -

- > Improve fuel consumption
- > Increase the tyre life span
- > Help enhance vehicle handling & braking
- > Reduce susceptibility to hydroplaning

System contents -

- 1 x Display
- 1 x Receiver
- 4 x Tyre sensors
- 3 x Display brackets,
- 2 x 3M stickers
- 1 x Instruction manual

WHEEL SPACERS & ADAPTOR KITS



DA2075



DA5005



DA5006



DA5004

Wheel Adaptor Kit

DA2075

To fit Range Rover L322 wheels to Range Rover P38

To fit Range Rover Sport wheels to Discovery 2

DA5005

To fit Range Rover P38 wheels to Range Rover Classic

DA5006

To fit Discovery 2 wheels to Defender

Wheel Spacers

DA5004

Defender/Range Rover Classic/Discovery 1

30mm thick, steel machine finish complete with wheel nuts and OEM studs

WHEEL WRENCHES



Wrench size - 15/16"

537179



Wrench size - 27mm

DA4026



Wrench size - 27mm

NTC7829



Wrench size - 27mm
Heavy-duty

NTC7829HD

WHEELS



ANR4583PM



ANR4583SILVER



ANR5307MNH



ANR5593PM



RRC503400MNH



RRC503600PM



ANR3631MNH



ANR1534PM



ANR4636PM



ANR4635PM



NTC5193PM



RRC114560MUW



RRC501470MCM



RRC505360MNH



ANR3973



RRC505370MNH

ANR4583PM Defender - use longer studs (FRC7577)
Steel Wolf rim welded tubeless 16" x 6.5J black

ANR4583SILVER Defender - use longer studs (FRC7577)
Steel Wolf rim welded tubeless 16" x 6.5J silver

ANR5307MNH Defender - from TA/Discovery 1
16" x 7 Tornado alloy

ANR5593PM Defender
Steel Wolf rim welded tube type 16" x 6.5J primed

RRC503400MNH Defender - 1987 onwards Boost alloy - 16" x 7

RRC503600PM Defender - 1987 onwards Steel tubeless - 16" x 5.5

ANR3631MNH Defender/Discovery 1 16" x 7 Deepdish alloy

ANR1534PM Defender/Series
Steel 1 ton 569204 welded 16" x 6.5 primed

ANR4636PM Defender/Series
Steel standard welded tube type 16" x 5.5F primed

ANR4635PM Defender/Range Rover Classic
16" x 6 Steel Ro-Style NTC2165 primed

NTC5193PM Discovery 1 Steel 16" x 7 primed

RRC114560MUW Discovery 2 Steel silver 16" x 7J

RRC501470MCM Discovery 2/Range Rover P38
18" x 8 Hurricane alloy

RRC505360MNH Discovery 3/Range Rover Sport
18" x 8 10 spoke alloy wheel - silver sparkle finish

ANR3973 Freelander Steel 15" x 5.5J

RRC505370MNH Range Rover Sport
19" x 9 alloy wheel - silver sparkle finish

Smarten up your Land Rover with a smart new set of alloy wheels.

ZU RIMS



- > Super strong
- > Super light
- > TÜV approved and meets or exceeds UK - European - U.S. - Canadian - Australian - South African and Japanese wheel manufacturing specifications
 - > Uses standard Land Rover alloy wheel nuts
- > Easy to balance
- > Manufactured in the UK

Super strong

Discovery 2/Range Rover P38

- > 38mm offset
- > 1,400kg rating
- > 12kg each

DA2430	16 x 8	White
DA2431	16 x 8	Silver
DA2432	16 x 8	Black - gloss
DA2438	16 x 8	Black - matt
DA2433	16 x 8	Anthracite

Defender/Discovery 1/Range Rover Classic

- > 11mm offset
- > 1,400kg rating
- > 10.4kg each

DA2434	16 x 7	White
DA2435	16 x 7	Silver
DA2436	16 x 7	Black - gloss
DA2439	16 x 7	Black - matt
DA2437	16 x 7	Anthracite

RRJ500030MNH	Wheel cap
Discovery 2/Range Rover P38	
ANR2763MMM	Alloy wheel nut
Defender up to 2006/Discovery 1/Range Rover Classic	
ANR3679	Alloy wheel nut
Discovery 2	



DA2437



DA2434

Super light



DA2435



DA2433



DA2431



DA2432

05

lighting equipment

LIGHTING EQUIPMENT

Be seen and light the way with a decent set of driving lamps.

Section contents -

Light bar	38
Light conversion kits	38
Light kits	38
Light mounting kits	40
Light upgrade kits	40
Lights - driving	39
Lights - fog	38
Lights - Roo-lites	40
Map reading lamp	41
NAS lights	41

Water splash
Picture courtesy of Simon Hodson

LIGHT BAR



DA5624

DA5624

Defender - non air-con models

Black finish

Note - Light bar exclude lights



DA5624

LIGHT CONVERSION KITS



RTC4615C

RTC4615C

Crystal halogen headlamp

Series/Defender/Range Rover Classic

> Clear lenses and profiled back reflector offer brilliant lighting

> Fully E-marked

> Pair

Note - Bulb not included

PRC7994K

Sealed beam to halogen

Series/Defender/Range Rover Classic

Left hand drive

Pair

RTC4615K

Sealed beam to halogen

Series/Defender/Range Rover Classic

Right hand drive

Pair



RTC4615K

LIGHT KITS



DA1077



DA1080

DA1077

Defender/Series

DA1080

Defender 300Tdi

LIGHTS - FOG



RTC8922

STC7643



RTC8922

Defender/Range Rover Classic

Hella Comet 550 rectangular - pair

Black

Note - 195mm wide x 96mm high x 83mm deep. 12 vol

STC7643

Hella Rallye 1000

Black

LIGHTS - DRIVING

DA4088	8" Light	Black	Pair
DA4088C	8" Light	Chrome	Pair
DA4088W	Wipac 8" Light > High power, 100 watt 8", halogen lamp > Easy installation > Fitted plastic stone guards	Black	Pair > Black body, chrome rim > Armoured cable
DA4088BULB	Replacement bulb for DA4088C	100 watt	
DA4088COVER	Replacement 8" spot light cover for DA4088/DA4088C/DA4088W		
DA4099	Hella Rallye 3000	Black	Single
PRC8238	Spoiler lamps classic	Black	Pair
STC7644	Hella Rallye 1000 long range	Black	Single
STC8480	Land Rover Safari 5000 Defender 1987-2006/Discovery 1/Discovery 2/Range Rover Classic 1992-1994/Range Rover P38	Black	Single
STC8842	Lamp guard for Land Rover Safari 5000 driving & fog lamp		Pair
VUB001090	Range Rover L322 driving light kit - includes electrics & fittings	Black	Pair
XQB500080	Discovery 3 driving light kit - includes electrics & fittings	Black	Pair
VUB500870 NEW	Freelander 1 from 4A00001 long range driving lamp kit Kit includes lamps, brackets, switch, looms and full fitting instructions	Black	Pair



DA4088



DA4088C



DA4088W



DA4088COVER



DA4099



PRC8238



STC7644



STC8480



STC8842



VUB001090



XQB500080



VUB500870

LIGHTS - ROO-LITES

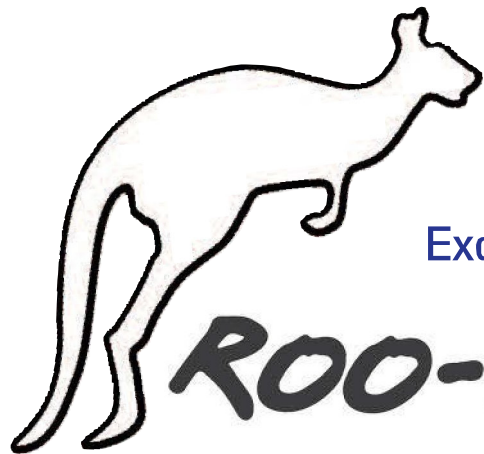

Exclusive to Britpart

ROO-LITE®

High performance lighting with super strength construction



DA1062 Roo-lite

- > High performance lighting with super strength construction
- > 7 1/4" round long range spot lamps with "stone-proof" clear polycarbonate lens
- > Super strength housing with an Osram 100 watt Xenophot long life technology bulb
- > Variable focus from spot to fog beam pattern
- > Lightweight for reduced vibration
- > Reflector unit is screw-on for easy bulb change
- > 12V - 100W - 8 amps

Note - Roolites sold individually

DA1062AMBER	Amber coloured cover
DA1062BLUE	Blue coloured cover
DA1062COVER	Protective cover

Note - Roolites covers sold individually

DA1063	Spare bulb
DA1064	Harness

- > Harness is of a heavy gauge wire to ensure safe operation of high wattage lamps. It includes digital switch, in-line fuse, built-in relay and wiring harness.

LIGHT MOUNTING KITS



DA3010
Series/Defender
8" Headlamp
Chrome

DA3010B
Series/Defender
8" Headlamp
Black

LIGHT UPGRADE KITS



STC50383
Range Rover P38
Right hand drive lamp upgrade kit
Note - Does not include headlamps

STC50408
Range Rover P38
Left hand drive lamp upgrade kit
Note - Does not include headlamps

Got something to tow?



Towing gear for all Land Rovers - see towing equipment section!

MAP READING LAMP



Flexible interior lamp!

AMR4910
Defender
24 volt

AMR4910

NAS LIGHTS



AMR6526



AMR6527



AMR6528



XFD500010



XFE500010

Defender lights with North American specification...

AMR6526	Round	Red	Stop or tail lamp
AMR6527	Round	Amber	Indicator lamp
Note - Supplied without mounting plinth and screws			
AMR6528	Round	Clear	Reverse or side lamp
Note - Supplied with mounting plinth but without screws			
XFD500010	Round	Clear	Reverse or side lamp
XFE500010	Round	Red	Rear fog lamp
Note - Supplied with mounting plinth and screws			

Sundry items			
AMR3850	Mounting plinth		
SE105161L	Screws		
STC1188	Link leads	2 wire for indicator, side, reverse and fog lamp	
STC4637	Link leads	3 wire for stop and tail lamp	

“ The Britpart logo has become a widely recognised and highly respected marque; it *embodies excellence* in the field, both in quality and commitment to meeting the needs of the customer. ”



06

towing equipment

TOWING EQUIPMENT

Haul that load - towing equipment for all Land Rover models.

Section contents -

All models	44
Defender	45
Discovery	46
Freelander	47
Range Rover	48
Series	48



Farmyard Defender
Picture courtesy of Greg Mawson

ALL LAND ROVER MODELS



67187



201691



DA2123

67187	All	Pin universal coupling HD (201691)
201691	All	Ball and jaw + pin HD 4 bolt mounted (ball 3 1/2 ton/jaw 5 ton)
579408	All	7-Pin trailer plug
ANR3635	All	50mm Tow ball cover
DA2123	All	Ball, jaw & pin (RTC8159)
DA2123A	All	Replacement chain, tag, clip
DA2194	All	Replacement pin for DA2123
DA2195	All	Replacement slider bracket - 1-pin
DA2118	All	Replacement slider bracket - 2-pin
DA2196	All	Replacement slider pin
DA2197	All	Replacement slider pin 'R Clip'
DA5100	All	Tow hitch - to tow 3,500kgs gross
KNB100640	All	Towing jaw (3 1/2 ton)
NRC2051	NATO	Tow hitch
RTC8831	All	Saddle slider - fits all Dixon Bates kits



NRC2051



DA2118



DA5100



RTC8831



Picture courtesy of John Brunnsden

DEFENDER



DA2123 / LR007221

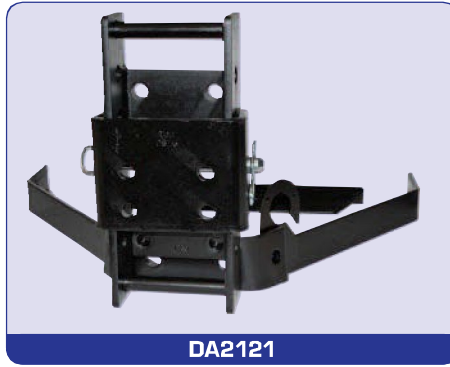

DA2121



DA2136



YWJ101500



RTC8891AA

DA2121	Defender	Adjustable kit (RTC8828)
DA2136	Defender 90 - from WA	Towbar assembly (VUB105460) - no electrics
DA2137	Defender 110 - from WA	Towbar assembly (VUB105470) - no electrics
LR007221	Defender Td5 90	Adjustable tow kit
LR007222	Defender Td5 110	Adjustable tow kit
RTC8891AA	Defender	50mm Tow ball
YWJ101500	Defender Td5	'N' Type electrics plug
STC50269AA NEW	Defender 90 from XA onwards	Rear step - includes regulation tow bracket Note - does not include drop plate and tow ball
STC50301 NEW	Defender 110 from XA onwards	Rear step - includes regulation tow bracket Note - does not include drop plate and tow ball



STC50269AA

Britpart have the equipment to get you hitched up and towing!



DISCOVERY



DA2125



DA2134



RTC8891AA



DA2138

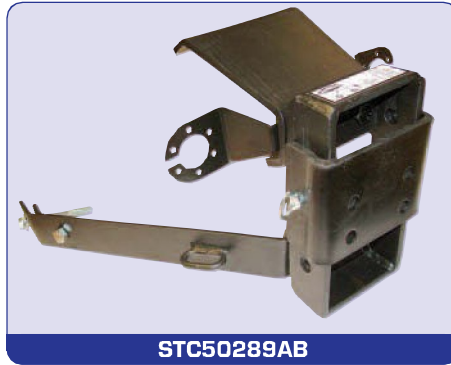

STC50289AB



KNB500070



LR007484



STC8919AA

DA2125	Discovery 1 - 1994 on	Adjustable coupling (RTC8830, STC8060)
DA2134	Discovery 1 - to 1994	Tow kit (STC8816) to 1994 - includes electrics but not plug-in electrics
RTC8891AA	Discovery 1	50mm Tow ball
DA2138	Discovery 2	Towing kit - includes electrics
STC50287AB	Discovery 2	Tow kit - coil suspension - no electrics
STC50289AB	Discovery 2	Tow kit - air suspension - no electrics
KNB500070	Discovery 3	Towing hook assembly - quick disconnect without height adjustment
LR007484	Discovery 3	Adjustable tow hook kit
STC8919AA	Discovery 3	Tow strap
YWJ500201	Discovery 3	Tow bar electrics kit 'N' & 'S' type



Picture courtesy of Victor Petrovsky

FREELANDER



VUB501500



LR002738



LR002742

KNK500070	Freelander 1	Towing kit - UK style 50mm ball fitted	Note - this has a plug connection to the vehicle loom - with electrics
STC50391	Freelander 1	Tow kit - includes electrics but not plug-in electrics or tow ball	
VUB501500	Freelander 1	Towing kit - swan neck detachable - with plug-in electrics	
LR002738	Freelander 2	Tow bracket kit	
LR002740	Freelander 2	Tow bracket kit - detachable ball tow bar	
LR002742	Freelander 2	Tow bracket kit - swan neck	
LR003106	Freelander 2	Electrics kit - 12N/12S 7 pin socket	
LR003107	Freelander 2	Electrics kit - 13 pin socket	



Picture courtesy of Jake Perks

RANGE ROVER



DA2134



RTC8829



KNB500070



LR007484



STC8919AA



VUB000720

DA2125	Range Rover Classic	Adjustable coupling (RTC8830, STC8060)
DA2134	Range Rover Classic	Tow kit (STC8816) to 1994 - includes electrics but not plug-in electrics
RTC8829	Range Rover Classic	Towing kit
DA4030	Range Rover P38	Tow kit
		Note - No tow ball included. It is not a Swan neck type, a standard 50mm tow ball is required (RTC8891AA). Electrics are included but not plug-in.
KNB500070	Range Rover Sport	Towing hook assembly - quick disconnect without height adjustment
LR007484	Range Rover Sport	Adjustable tow hook kit
STC8919AA	Range Rover Sport	Tow strap
STC8919AA	Range Rover L322	Tow strap
VUB000720	Range Rover L322	Multi-height tow bar - includes carry bag
VUB000730	Range Rover L322	Quick release tow bar
VUB000740	Range Rover L322	Tow bar armature - towing subframe - pre 2006 model years
		Note - The tow bar armature accepts quick release, multi-height tow bars and bike carrier
VUB503960	Range Rover L322	Tow bar armature - towing subframe - 2006 model year only
YWC000840	Range Rover L322	Towing electrics control unit
YWJ500450	Range Rover L322	Tow bar electrics kit 12'N' & 12'S' type



A full range of filters available from Britpart
See service kits & filter section

SERIES



DA2122



RTC8891AA



DA2129

DA2012	Series SWB	Plate and bracket (short)	RTC8891AA	Series	50mm Tow ball
DA2122	Series	Adjustable kit	DA2129	Lightweight	Adjustable tow hitch
DA2133	Series 88/109	Drop plate extension			

07

interior protection

INTERIOR PROTECTION

Loadspace liners, mats and of course, dog guards - all that you need to protect and keep your Land Rover looking great inside.

Section contents -

Dog guards	50 - 51
Gear box gaiters	51
Loadspace liners	52 - 53
Loadspace nets & retention kit	54
Mats	55 - 56
Waterproof seat covers	57 - 58
Wind deflectors	59

"I'm going to get very muddy in a minute - once you get me down from up here"
Picture of Kelo courtesy of Richard Reid

DOG GUARDS

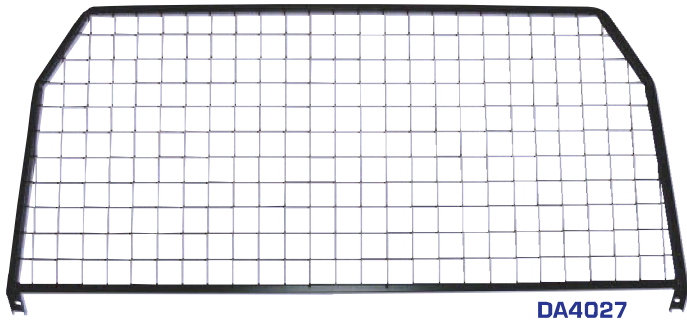

DA4027

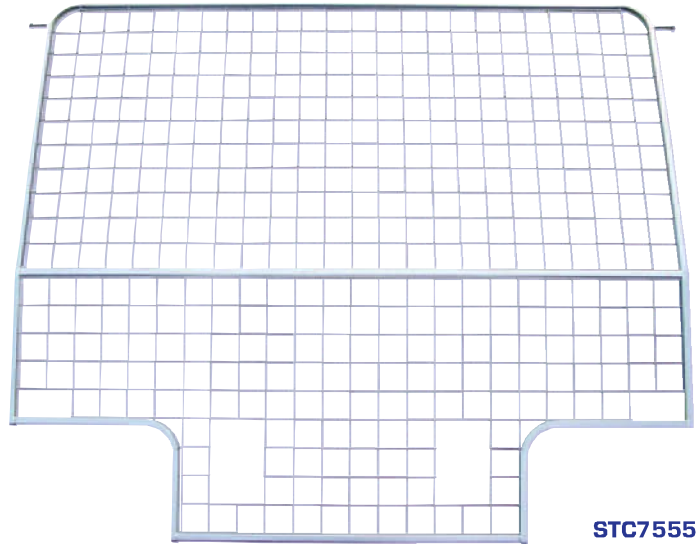

STC7555

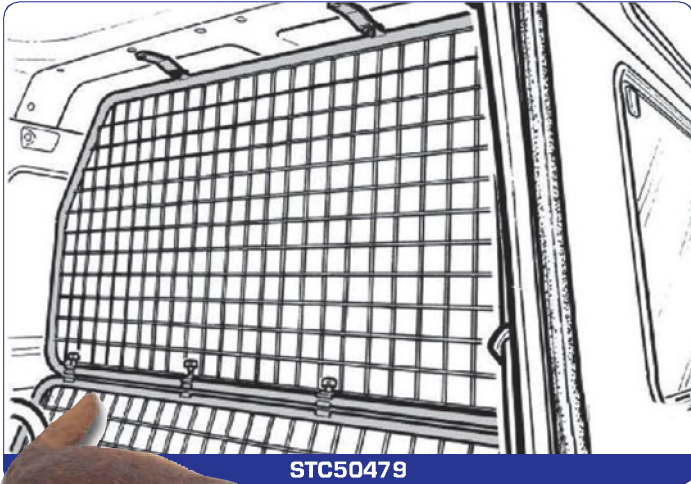

STC50479

Defender/Series

DA4027	Series/Defender to 2002 Mesh type	Black
STC7555	Defender 110 County Station Wagon Mesh type	Grey
STC50479	Defender 90 Full height guard for vehicles without a bulkhead Mesh type	Grey



Keep Rover in his place!

Discovery

STC7570	Discovery 1	Bar type	Half length	Grey
STC8414	Discovery 1	Mesh type	Half length	Grey
STC50323	Discovery 2 - 2003	Mesh type	Half length	Grey
STC50082AA	Discovery 2	Bar type	Half length	Grey
DA5511	Discovery 3	Mesh type	Half length	Grey
VUB501170	Discovery 3	Mesh type	Full length	Black



STC7570

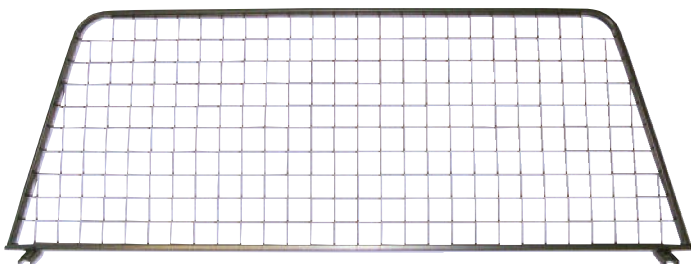

STC8414

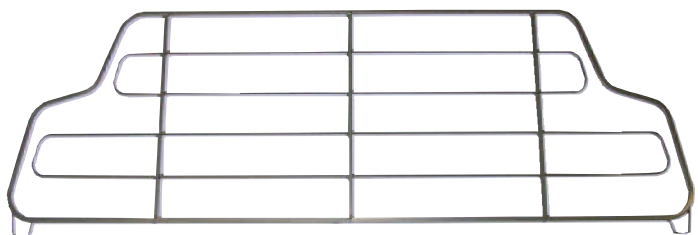

STC50082AA



STC50323



DA5511



VUB501170

DOG GUARDS - continued



STC7939AB



DA5801



LR002521

Freelander

STC7939AB	Freelander 1	Bar type	Floor to roof	Grey
DA5801	Freelander 2	Half height	Full width	Grey
Easy to fit and remove. No vehicle modifications needed.				
LR002521	Freelander 2	Full height	Full width	Black
LR002522	Freelander 2	Full height	Half width	Black

Range Rover

DA4141	Range Rover - 1986 - 1994	Mesh type	Black
RTC8093	Range Rover Classic - to 1994	Bar type	Grey
STC8524	Range Rover P38	Tubular type	Grey
VUB002120	Range Rover L322	Mesh type	Black
DA1081	Range Rover Sport	Mesh type	Dark grey



LR002522

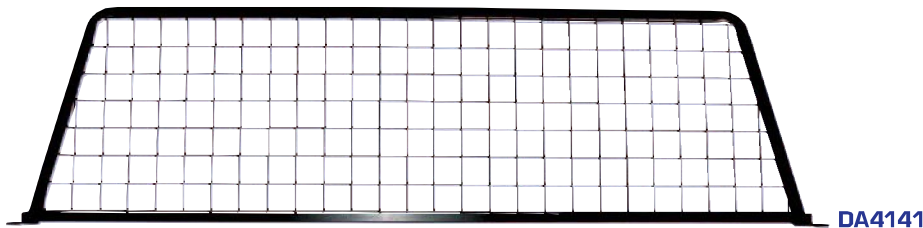

DA4141



VUB002120



RTC8093



STC8524



DA1081

GEAR BOX GAITERS

Got a Defender with a tatty gear box gaiter? Well replace it with a smart new hard wearing one from Britpart!

DA5498	Grey
DA5499	Black

For details of the alloy gear stick knobs [DA5500] see the Vehicle Enhancement section.

Smarten up your Defender's interior!



DA5498

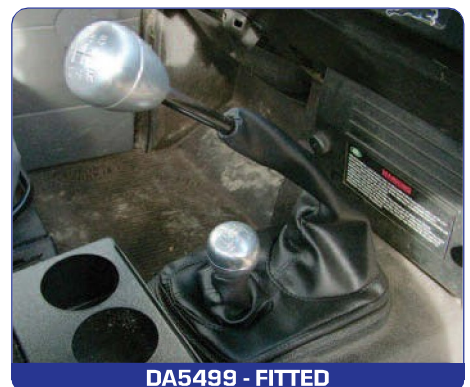

DA5499 - FITTED

LOADSPACE LINERS



DA4470

Defender

DA4470 Defender 90 Rubber



DA4183



DA4169

And now she needs a lift home in the back of your nice clean Land Rover...

Keep your Land Rover's interior clean and tidy!



STC50050



STC50052AA



STC50053AA



DA5602



EBF500010



LR003895

Discovery

DA4183	Discovery 1	Loadspace liner	2" deep sides	Semi-rigid
DA4169	Discovery 2	Loadspace liner	3" deep sides	Semi-rigid
STC50050	Discovery 2	Note - trim required for air-con models Loadspace liner	5" deep sides	Rigid
STC50052AA	Discovery 2	Loadspace mat	Half length	Rubber
STC50053AA	Discovery 2	Loadspace mat	Full length	Rubber
DA5602	Discovery 3	Loadspace liner	3" deep sides	Semi-rigid
EBF500010	Discovery 3	Loadspace liner	6" deep sides	Rigid
LR003895	Discovery 3	Loadspace mat	Full length	Rubber

LOADSPACE LINERS - continued



DA4171



STC50435



DA5554



LR002516



LR002424



Shown here fitted to a Range Rover Sport

VPLFS0014

Freelander

DA4171	Freelander 1	Loadspace liner	2" deep sides	Semi-rigid
STC50435	Freelander 1	Loadspace mat		Rubber
DA5554	Freelander 2	Loadspace liner	2" deep sides	Semi-rigid
LR002516	Freelander 2	Loadspace mat		Rubber
LR002424	Freelander 2	Loadspace liner	3" deep sides	Semi-rigid
VPLFS0014	Freelander 2	Luggage compartment protection		



DA4170



DA5555



VPLSS0016



DA5556



EBF000040



LR003894

Range Rover

DA4170	Range Rover P38	Loadspace liner	3" deep sides	Semi-rigid
DA5555	Range Rover Sport	Loadspace liner	2" deep sides	Semi-rigid
VPLSS0016	Range Rover Sport	Luggage compartment protection		
DA5556	Range Rover L322	Loadspace liner	2" deep sides	Semi-rigid
EBF000040	Range Rover L322	Loadspace liner	6" deep sides	Rigid
LR003894	Range Rover L322	Loadspace mat		Rubber

LOADSPACE NETS & RETENTION KIT**VUB000700****VUB000710****VUB000700**

Range Rover L322
 Loadspace retention kit
 Restricts the movement of goods in the rear of the vehicle.

Contents - 1 x floor net & 2 x ratchet straps

VUB000710

Range Rover L322
 Luggage nets
 A convenient way of storing luggage to maximise load space.

Contents - 2 x side nets



MATS



331401



DA4503



BTR7895



BTR7896



BTR7897



BTR7898

Defender Rubber Mats

Individual Mats

331401	SWB Series 88 & Defender 90	Floor only	
DA4503	110 Hard top & truck cab		Rear loadspace mat
	5mm rubber with 6mm foam backing - 93 x 198cm		
BTR7895	LT77 Gearbox	Front floor left hand	Heavy duty with foam backing
BTR7896	LT77 Gearbox	Front floor right hand	Heavy duty with foam backing
BTR7897	1993 on	Front floor left hand	Heavy duty with foam backing
BTR7898	1993 on	Front floor right hand	Heavy duty with foam backing

Mat Sets

DA4501	LT77 Gearbox	Front right & left hand	Contains - BTR7895 & BTR7896
DA4502	1993 on	Front right & left hand	Contains - BTR7897 & BTR7898
LR005039	2007 MY onwards	Front right & left hand	
STC50172	Pre-2007 MY	Front right & left hand	

Keep your Land Rover interior clean with a set of mats from Britpart



DA4422



DA4423



DA4426



DA4427



DA4424



DA4425



DA4428



DA4429



DA4430



DA4431

Quality Rubber Over Mats

DA4422	Series 2 & 3	Front	Black	Pair
DA4423	Defender	Front	Black	Pair
DA4426	Discovery 1	Front	Black	Pair
DA4427	Discovery 1	Rear	Black	Pair
DA4424	Discovery 2	Front	Black	Pair
DA4425	Discovery 2	Rear	Black	Pair
DA4428	Freelander 1	Front	Black	Pair
DA4429	Freelander 1	Rear	Black	Pair
DA4430	Range Rover P38	Front	Black	Pair
DA4431	Range Rover P38	Rear	Black	Pair

MATS - continued



DA4022BLACK



DA4023GREY



DA4024BLUE



LR002485



LR006435



EAH000300SUN



EAH500052PMA



EAH500054PMA

Carpet Mat Sets

DA4022BLACK	Defender	Black
DA4023BLACK	Discovery 1	Black
DA4023BLUE	Discovery 1	Blue
DA4023GREY	Discovery 1	Grey
DA4024BLUE	Range Rover Classic - 1986 on	Blue

Note - Front and rear carpet sets with rubber backing

Protect your vehicle interior with a set of smart floor mats

Premium Mats - Carpet With Rubber Backing NEW

LR002484	Freelander 2	Front & rear contour set	RHD	Ebony black
LR002486	Freelander 2	Front & rear contour set	LHD	Ebony black
LR002485	Freelander 2	Front & rear contour set	RHD	Alpaca beige
LR002497	Freelander 2	Front & rear contour set	LHD	Alpaca beige
LR006431	Discovery 3	Front & rear contour set	RHD	Ebony black
LR006432	Discovery 3	Front & rear contour set	LHD	Ebony black
EAH500010PVJ	Discovery 3	Front & rear floor set	RHD	Ebony black
EAH500080PVJ	Discovery 3	Front & rear floor set	LHD	Ebony black
LR006433	Discovery 3	Front & rear contour set	LHD	Alpaca beige
VPLAS00022PVJ	Discovery 4	Front & rear contour set	RHD	Ebony black
VPLAS00023PVJ	Discovery 4	Front & rear contour set	LHD	Ebony black
LR006434	Range Rover Sport	Front & rear contour set	RHD	Aspen
LR006436	Range Rover Sport	Front & rear contour set	LHD	Aspen
EAH500012LUP	Range Rover Sport	Front & rear floor set	RHD	Aspen
EAH500011LUP	Range Rover Sport	Front & rear floor set	LHD	Aspen
LR006435	Range Rover Sport	Front & rear contour set	RHD	Ebony black
LR006437	Range Rover Sport	Front & rear contour set	LHD	Ebony black
EAH500012PVJ	Range Rover Sport	Front & rear floor set	RHD	Ebony black
EAH500011PVJ	Range Rover Sport	Front & rear floor set	LHD	Ebony black
LR006438	Range Rover Sport	Front & rear contour set	LHD	Alpaca beige
EAH500015SMS	Range Rover Sport	Front & rear floor set	LHD	Alpaca beige
EAH000300JMN	Range Rover L322 up to 6A	Front & rear contour set	RHD	Navy
EAH000310JMN	Range Rover L322 up to 6A	Front & rear contour set	LHD	Navy
EAH500280JMN	Range Rover L322 from 7A	Front & rear contour set	RHD	Navy
EAH500290JMN	Range Rover L322 from 7A	Front & rear contour set	LHD	Navy
EAH000300LUP	Range Rover L322 up to 6A	Front & rear contour set	RHD	Aspen
EAH000310LUP	Range Rover L322 up to 6A	Front & rear contour set	LHD	Aspen
EAH500280LUP	Range Rover L322 from 7A	Front & rear contour set	RHD	Aspen
EAH500290LUP	Range Rover L322 from 7A	Front & rear contour set	LHD	Aspen
EAH000300PVA	Range Rover L322 up to 6A	Front & rear contour set	RHD	Jet
EAH000310PVA	Range Rover L322 up to 6A	Front & rear contour set	LHD	Jet
EAH500280PVA	Range Rover L322 from 7A	Front & rear contour set	RHD	Jet
EAH500290PVA	Range Rover L322 from 7A	Front & rear contour set	LHD	Jet
EAH000300SUN	Range Rover L322 up to 6A	Front & rear contour set	RHD	Sand
EAH000310SUN	Range Rover L322 up to 6A	Front & rear contour set	LHD	Sand
EAH500280SUN	Range Rover L322 from 7A	Front & rear contour set	RHD	Sand
EAH500290SUN	Range Rover L322 from 7A	Front & rear contour set	LHD	Sand

Premium Mats - Rubber NEW

LR002481	Freelander 2	Front & rear contour set	RHD	Black
LR002483	Freelander 2	Front & rear contour set	LHD	Black
LR006237	Discovery 3 & 4	Front & rear contour set	RHD	Black
LR006238	Discovery 3 & 4	Front & rear contour set	LHD	Black
EAH500100PMA	Discovery 3 & 4	3rd Row floor mat	N/A	Black
EAH500052PMA	Discovery 3	Front & rear floor set	RHD	Black
EAH500050PMA	Discovery 3	Front & rear floor set	LHD	Black
EAH500058PMA	Discovery 3	Front contour set	RHD	Black
EAH500057PMA	Discovery 3	Front contour set	LHD	Black
LR006241	Range Rover Sport	Front & rear contour set	RHD	Black
LR006242	Range Rover Sport	Front & rear contour set	LHD	Black
EAH500054PMA	Range Rover Sport	Front & rear floor set	RHD	Black
EAH500051PMA	Range Rover Sport	Front & rear floor set	LHD	Black
EAH500320PMA	Range Rover L322	Front & rear contour set	RHD	Black
EAH500330PMA	Range Rover L322	Front & rear contour set	LHD	Black
EAH000261PMA	Range Rover L322	Front & rear floor set	RHD	Black
EAH000271PMA	Range Rover L322	Front & rear floor set	LHD	Black

WATERPROOF SEAT COVERS



DA2815GREY

Defender - up to 2007
3 Seats - Front

DA2815BLACK **DA2815BLUE**
DA2815GREEN **DA2815GREY**

Covers in kit -
3 x full seat (excludes headrest covers)



DA2816GREY

Defender - up to 2007 - 2nd Row
110 Station Wagon - 60/40

DA2816BLACK **DA2816BLUE**
DA2816GREEN **DA2816GREY**

Covers in kit -
1 x two-seat back & cushion
1 x one-seat back & cushion
Note - Will fit 110 Crew Cab with minor modification to seat covers.

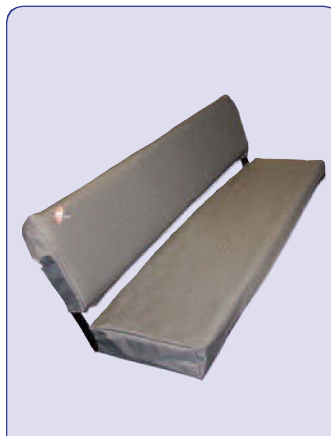

DA2817GREY

Defender - up to 2007
110 Station Wagon

- Bench Rear Inward Facing
DA2817BLUE **DA2817GREEN**
DA2817GREY

Covers in kit -
2 x bench-seat back & cushion
Note - For 1,200mm long seat



DA2818BLACK

Defender 2007 - onwards
Front

DA2818BLACK
Covers in kit -
2 x full seat 2 x headrest



DA2807GREY

Discovery 1 - Front
DA2807BLACK **DA2807BLUE**
DA2807GREEN **DA2807GREY**

Covers in kit -
2 x full seat



DA2808GREY

Discovery 1 - Rear
DA2808BLACK **DA2808BLUE**
DA2808GREEN **DA2808GREY**

Covers in kit -
1 x two-seat back & cushion
1 x one-seat back & cushion



DA2809GREY

Discovery 1 - Boot
DA2809BLUE **DA2809GREEN**
DA2809GREY

Covers in kit -
2 x full seat

What better way to protect your Land Rover seats than these waterproof covers from Britpart?



- > An extensive range of quality and stylish waterproof seat cover sets.
- > Front and rear sets available with headrests and armrests included in the Range Rover and Freelander range. Rear inward facing sets are also available for the 7-seater Discovery models.
- > The hard-wearing washable covers are made from waterproof woven polyester with a PVC backing.
- > Snug, tailor fit covers available in 3 stylish colours.
- > Easy to put on the seats and just as easy to remove again.



DA2800BLUE

Discovery 2 - Front
DA2800BLACK **DA2800BLUE**
DA2800GREEN **DA2800GREY**

Covers in kit -
2 x full seat 2 x headrest
2 x armrest



DA2801BLUE

Discovery 2 - Rear
DA2801BLACK **DA2801BLUE**
DA2801GREEN **DA2801GREY**

Covers in kit -
1 x two-seat back & cushion
1 x full seat 1 x armrest
3 x headrest



DA2802BLUE

Discovery 2 - Boot
DA2802BLUE
DA2802GREEN **DA2802GREY**

Covers in kit -
2 x full seat
2 x roof headrest (not shown)

Discovery 3 - Front
DA2822BLACK
Covers in kit -
2 x full seat 2 x headrest
2 x armrest
Note - suitable for vehicles with side air bags

WATERPROOF SEAT COVERS - continued



DA2810GREEN

Freeland 1
3 Door - Front
DA2810BLACK DA2810BLUE
DA2810GREEN DA2810GREY

Covers in kit -
 2 x back, cushion & headrest

Freeland 1
3 Door Sport - 2 Rear Seats
DA2812BLUE DA2812GREEN
DA2812GREY

Covers in kit -
 2 x back, cushion & headrest



DA2811BLUE

Freeland 1
5 Door - Front
DA2811BLACK DA2811BLUE
DA2811GREEN DA2811GREY

Covers in kit -
 2 x back, cushion & headrest

Freeland 2
Front
DA2821BLACK

Covers in kit -
 2 x full seat 2 x headrest
 2 x armrest



DA2813GREEN

Freeland 1
3 or 5 Door - Rear
60/40 split without armrest
DA2813BLUE DA2813GREEN
DA2813GREY

Covers in kit -
 1 x two-seat back & cushion
 1 x one-seat back & cushion
 3 x headrest



DA2814BLUE

Freeland 1
3 or 5 Door - Rear
60/40 split with armrest
DA2814BLUE DA2814GREEN
DA2814GREY

Covers in kit -
 1 x two-seat back & cushion
 1 x one-seat back & cushion
 3 x headrest *pre-Td4 only



DA2803GREY

Range Rover Classic
4 Door - Front
DA2803BLACK DA2803BLUE
DA2803GREEN DA2803GREY

Covers in kit -
 2 x back, cushion, armrest & headrest



DA2804GREY

Range Rover Classic
4 Door - Rear
DA2804BLUE DA2804GREEN
DA2804GREY

Covers in kit -
 1 x two-seat back & cushion
 1 x one-seat back & cushion
 3 x armrest



DA2805BLUE

Range Rover P38 - Front
DA2805BLUE DA2805GREEN
DA2805GREY

Covers in kit -
 2 x full seat, headrest & armrest
Note - Not suitable for vehicles with rear air bags mounted in the front seats.



DA2806BLUE

Range Rover P38 - Rear
DA2806BLUE DA2806GREEN
DA2806GREY

Covers in kit -
 1 x two-seat back & cushion
 1 x one-seat back & cushion
 3 x headrest 1 x armrest

Range Rover Sport - Front
DA2819BLACK

Covers in kit -
 2 x full seat 2 x headrest
 2 x armrest

Range Rover L322 - Front
DA2820BLACK

Covers in kit -
 2 x full seat 2 x headrest
 2 x armrest



Helping you protect your Land Rover!

Waterproof Seat Covers - Other

LR005058	Freeland 2	Front	Aspen
LR005059	Freeland 2	Front	Sand
DA4083	Range Rover Classic	Front & rear	Grey/Navay
HBD000320JMN	Range Rover L322	Front set	Navay
	Standard seats including head and arm rest - pair		
HBD000320LUP	Range Rover L322	Front set	Aspen
	Standard seats including head and arm rest - pair		
HBD000320LYR	Range Rover L322	Front set	Charcoal
	Standard seats including head and arm rest - pair		
HBD000320SUN	Range Rover L322	Front set	Sand
	Standard seats including head and arm rest - pair		



WIND DEFLECTORS



DA6070



DA6071



DA4175



DA6072



DA6073



DA6077



DA6074



DA6075



DA6076

DA6070 NEW	Discovery 1/Range Rover Classic	Front & rear	4 piece kit
DA6071 NEW	Discovery 2	Front & rear	4 piece kit
DA4175	Discovery 2	Front	2 piece kit
DA6072 NEW	Discovery 3	Front & rear	4 piece kit
DA6073 NEW	Freelander 1 - 2 door	Front	2 piece kit
DA6077 NEW	Freelander 1	Front & rear	4 piece kit
DA6074 NEW	Freelander 2	Front & rear	4 piece kit
DA4176	Range Rover Classic	Front	2 piece kit
DA4177	Range Rover P38	Front	2 piece kit
DA6075 NEW	Range Rover L322	Front & rear	4 piece kit
DA6076 NEW	Range Rover Sport	Front & rear	4 piece kit
VUB502390	Discovery 3	Front & rear	4 piece kit
VUB000610	Range Rover L322	Front & rear	4 piece kit
VUB502520	Range Rover Sport	Front & rear	4 piece kit

Allows for fresh air to enter the vehicle by enabling the driver to have the windows open whilst being shielded from the wind and rain. Custom designed for each vehicle and easily attached using the fitting kit supplied - no drilling required for install.



Picture courtesy of Pascal Perrier



Picture courtesy of Guy Stryckmans

SEATS & TRIM

Saggy old seats? Get a set of smart new ones. We've plenty to choose from in a multitude of materials and colours. Also keep your vehicle clutter free with a cubby box.

Section contents -

Cubby boxes	62 - 63
Door trim	63
Extended slide seat rails & bulkhead bars	64
Fume curtain	64
Hoods	64
Re-trim kits - Defender	65
Seats - Defender & Series	66
Seats - Techno style	67
Seats - XS style	67
Trim	68



Inside view of the Britpart Trim Shop

CUBBY BOXES - DEFENDER & SERIES



DA2035T

RANGE IMPROVED
NOW WITH DOUBLE CUP HOLDER

Defender/Series 3 Cubby Boxes

With a Britpart cubby box in your Land Rover you can ensure your vehicle remains clutter free with these handy storage devices. Now with a double cup holder as standard, spilt drinks are a thing of the past. If security is a worry, then peace of mind can be achieved with our cubby box made from metal with a padded lid which is lockable.

	Top	Body
DA2035	Black	Black
DA2035LCS	Grey	Grey
DA2035RPI	Vinyl twill	Grey
DA2035T	Techno	Grey
DA2149	Grey	Black

Security box - 2 keys & 3 removable cup holders

**Defender Cubby Box Cup Holder
FWJ500020PMA**

Double cup holder for both old and new model Defenders - ideal for holding a Britpart travel mug or two!! **Note** - To fit to existing carpet lined cubby box the lining may have to be taken out. Fits XS Style cubby boxes too.

Excludes travel mug -

DA8015



FWJ500020PMA



DA2035



DA2035LCS



DA2035RPI



DA2149

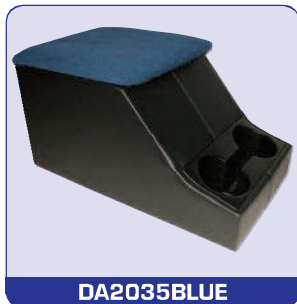

DA2035BLUE



DA2035BROWN



DA2035CHAR



DA2035GREEN



DA2035GREY

Keep your Defender & Series 3 clutter free!

XS Style Cubby Boxes

Hand-built in the UK, these quality XS style cubby boxes are suitable for Series 3 and Defenders. Well crafted with precision tools using a hard wearing leatherette outer and velour trim inner. Each box has locking stay brass hinges. These XS Style cubby boxes match our range of XS Style seats - see this section. Now with a double cup holder as standard, spilt drinks are a thing of the past.

	Top	Body
DA2035BLUE	Blue	Black
DA2035BROWN	Light brown	Dark brown
DA2035CHAR	Charcoal	Black
DA2035GREEN	Green	Black
DA2035GREY	Light grey	Dark grey



Picture courtesy of Kristjan Kristjansson

CUBBY BOXES - FREELANDER



DA5101



DA5103



DA5113

Add some extra storage space in a Freelander 2 with one of these stylish cubby boxes.

- > Innovative design
- > Strong ABS storage base
- > Large storage capacity
- > Easy do-it-yourself installation in only 5 minutes in the original point
- > Boxes for vehicles with no factory fitted armrests have adjustable sliding tops

Freelander 2 with no factory fitted armrests

DA5101	RHD	Black real leather
DA5102	RHD	Black eco leather
DA5103	RHD	Alpaca leather
DA5113 NEW	RHD	Almond leather
DA5104	LHD	Black real leather
DA5105	LHD	Black eco leather
DA5106	LHD	Alpaca leather
DA5114 NEW	LHD	Almond leather

Freelander 2 with factory fitted armrests

DA5115 NEW	Black real leather
DA5109 NEW	Black eco leather
DA5111 NEW	Alpaca leather
DA5112 NEW	Almond leather

Note - for both RHD & LHD vehicles



DA5111

Freelander 1 - 2001 - 2006

Add some support to your Freelander with one of these stylish adjustable armrests.

- > Innovative design
- > Easy do-it-yourself installation

DA5116 NEW

Black eco leather

DA5117 NEW

Black real leather

DA5118 NEW

Smokestone real leather



DA5118

DA5116



DOOR TRIM NEW



DA2124



DA2029



DA2441

DA2124	Defender/Series	Door trim safari	Rear		
DA2029	Series	Door trim lower	RH		
DA2030	Series	Door trim lower	LH		
DA2440	Defender	Door casing	Manual window	Black	RHS
DA2441	Defender	Door casing	Manual window	Black	LHS
DA2442	Defender	Door casing	Manual window	Grey	RHS
DA2443	Defender	Door casing	Manual window	Grey	LHS
DA2444	Defender	Door casing	Electric window	Black	RHS
DA2445	Defender	Door casing	Electric window	Black	LHS
DA2446	Defender	Door casing	Electric window	Grey	RHS
DA2447	Defender	Door casing	Electric window	Grey	LHS

Replace your Defender's old tatty door cards with one of these smart plastic replacements. Easy to fit they are also easy to keep clean with a wipe clean finish.

EXTENDED SLIDE SEAT RAILS & BULKHEAD BARS



DA2148

DA2148

Give your Defender seats 3" of extra slide with a pair of these seat rails. Ideal for the taller driver to give a more practical and comfortable driving position. One pair of rails is suitable for one seat.

- > Ideal for the taller driver
- > A more practical and comfortable driving position



DA2351

DA2351

Up until recently, Land Rover hasn't catered (in the Defender) for the people with stature. The bulk head removal bar alleviates the problem without compromising strength. The bulk head removal bar allows an extra 105mm of seat rake at the top and 50mm of travel on the seat base. The tubular bar creates a rigid bracing for the front of the Defender tub. As well as the added benefits of extra room in the vehicle due to the seats been more manoeuvrable, access to the rear of the Defender is now not compromised by a higher bulk head. Powder coated and supplied complete with all the necessary fixings.

FUME CURTAIN



MRC3519

MRC3519

Series & Defender

Note - Hood stick not included - 330553

HOODS

Got a Land Rover with a hood that has seen better days? Tears? Frayed fixings? Scratched windows? Well give your vehicle a quick facelift with a new canvass hood from Britpart.

- > Hoods are made from the original 18oz canvas and made to OEM specifications
- > All fittings are brass and made to OEM specifications
- > Webbing is made the same way as the original
- > Polypropylene rope is the same construction as the original rope
- > Ropes are all inserted into the hood to help customers
- > Care instruction are included

Other hoods available on request - please ask for details.

331110AG	Series	88"	Full hood	Khaki	Without windows
331113AG	Series	88"	Full hood	Khaki	With windows
331110SA	Series	88"	Full hood	Sand	Without windows
331113SA	Series	88"	Full hood	Sand	With windows
331371AG	Series	88"	Three quarters hood	Khaki	Without windows
331259AG	Series	109"	Full hood	Khaki	Without windows
331260AG	Series	109"	Full hood	Khaki	With windows
331259SA	Series	109"	Full hood	Sand	Without windows
331260SA	Series	109"	Full hood	Sand	With windows
331308AG	Series	109"	Three quarters hood	Khaki	Without windows
MUC2437	Series	109" - V8	High capacity pick-up Three quarters hood	Khaki	Without windows
MUC4122ABE	Defender	90	Full hood	Sand	With windows



331110AG - SIDE VIEW



331110AG - REAR VIEW



331113AG



331371AG

RE-TRIM KITS - DEFENDER

Going off-road? Got a working Land Rover?

Well the chances are your seats won't be in showroom condition, luckily here at Britpart we have the answer - a Defender re-trim kit.

Outer Seats - up to 2007

An outer Britpart re-trim kit includes:

1 x Fitment guide CD - This 20 minute tutorial will give you a detailed step-by-step guide to disassembling and assembling your Defender seat and information on the correct use of the included parts.

- | | |
|-----------------------------------|---------------------|
| 1 x Can of contact adhesive spray | 1 x Cushion foam |
| 1 x Squab foam | 1 x Cushion cover |
| 1 x Squab cover | 1 x Headrest cover |
| 6 x Plastic nails | 2 x Metal rods |
| 3 x Cable ties | 1 x Rubber retainer |

DA5627	Vinyl twill
DA5628	Techno
DA5629	Black
DA5630	Grey



DA5628

Centre Seats - 1990 onwards

A centre Britpart re-trim kit includes:

- | | |
|-----------------------------------|---------------------|
| 1 x Can of contact adhesive spray | 1 x Cushion foam |
| 1 x Squab foam | 1 x Cushion cover |
| 1 x Squab cover | 6 x Plastic nails |
| 1 x Metal rods | 1 x Rubber retainer |

DA5632	Vinyl twill
DA5633	Techno
DA5634	Black
DA5635	Grey



DA5634

Breathe life back into your old saggy Defender seats with a Britpart re-trim kit.



Swatches

Material colours are an approximate match. Sample swatches of the actual material are available on request.



SEATS - DEFENDER & SERIES



Defender Seats

DA4028	Seat cover	Base outer	Black
DA4041	Seat cover	Back outer	Black
MWC3302	Seat	Back RH	Black
MWC3303	Seat	Back LH	Black
MWC4535	Seat	Base outer	Black
MWC1010	Headrest assembly		Black
DA4029	Seat cover	Base outer	Grey
DA4042	Seat cover	Back outer	Grey
MWC5670LCS	Seat	Base outer	Grey
MWC9843LCS	Seat	Back LH	Grey
MWC9844LCS	Seat	Back RH	Grey
MWC5628LCS	Headrest assembly		Grey
AWR5701RPI	Seat cover	Base outer	Vinyl twill
AWR5702RPI	Seat cover	Back outer	Vinyl twill
AWR5708RPI	Headrest assembly		Vinyl twill
AWR5700RPI	Seat	Base outer	Vinyl twill
BTR8140RPI	Right hand assembly	Less headrest	Vinyl twill
BTR8141RPI	Left hand assembly	Less headrest	Vinyl twill
DA4031	Seat foam	Base outer	
DA4055	Seat foam	Back outer	
DA4056	Seat foam	Centre to 07/95	

Defender & Series Seats

320737	Bench seat	Rear assembly SWB	Black
DA3059	Bench seat	Rear assembly LWB	Black
DA4067	Rear seat	Individual inward facing	Black
320737CB	Bench seat	Rear assembly SWB	County brown
320737CG	Bench seat	Rear assembly SWB	County grey
320737LCS	Bench seat	Rear assembly SWB	Grey
DA4075	Rear seat	Individual inward facing	Grey
320737T	Bench seat	Rear assembly SWB	Techno style
DA4075T	Rear seat	Individual inward facing	Techno style
320737RPI	Bench seat	Rear assembly SWB	Vinyl twill
DA4075RPI	Rear seat	Individual Inward facing	Vinyl twill

Series Seats

320698	Seat back - pin fitment - adjustable	Standard outer	Black
320699	Seat base - adjustable	Standard outer	Black
320726	Seat base	Standard centre	Black
349967	Seat base	Standard outer	Black
MUC1488	Seat back	Standard centre	Black
MUC1520	Seat back - pin fitment	Standard outer	Black
MUC1520G	Seat back - bolt fitment	Standard outer	Black
DA4305	Standard seat kit		
Note - Kit contains - 2 x 349967; 2 x MUC1520; 1 x 320726 & 1 x MUC1488			
MRC6980	Seat base	Deluxe outer	Black
MRC6982	Seat back	Deluxe outer	Black
MRC6982H	Seat back with headrest	Deluxe outer	Black
MRC6985	Seat base	Deluxe centre	Black
MTC3181	Seat back	Deluxe centre	Black
DA4298	Deluxe seat kit		
Note - Kit contains - 2 x MRC6982; 2 x MRC6980; 1 x MTC3181 & 1 x MRC6985			

All products leaving the Trim Shop are produced to the highest standards!



A COMPLETE BRITPART SEAT

The skilled team in the Trim Shop make a wide range of seats and seat covers for Land Rover vehicles by hand. The material arrives in vast reams and has to be cut with great precision before being stitched together and then assembled into seat bases, seat backs, seat benches etc. In keeping with the Britpart philosophy, all products leaving the Trim Shop are produced to the highest standards and meet with the strictest safety regulations.



320737



DA4298



MRC6982H

SEATS - TECHNO STYLE

Hand-built in the UK, these quality seats with the ever popular 'Techno' pattern are suitable for Defenders. Well-crafted with precision tools using a hard wearing velour trim. Comfort is ensured with injection moulded foam.

HAG100970LOY	Base	
HCA106010LOY	Cover base	
HAI101400LOY	Squab assembly - no pockets	Right hand side
HAI101410LOY	Squab assembly - no pockets	Left hand side
HBA106190LOY	Squab cover - no pocket	
HBA106180LOY	Squab cover - with pocket	
HAH103510LOY	Headrest	
320737T	Rear seat assembly	
DA4075T	Rear seat individual inward facing	
HHD102280	Runner & sub-frame	Right hand side
HHD102290	Runner & sub-frame	Left hand side



320737T

Swatches
Material colours are an approximate match. Sample swatches of the actual material are available on request.



TECHNO



SEATS - XS STYLE

Hand-built in the UK, these quality XS style seats are suitable for Defenders. Well-crafted with precision tools using a hard wearing leatherette outer and velour trim inner. Comfort is ensured with injection moulded foam. Seats complete with base, back and headrest but the runners are not included.

	Outer	Inner	Side
DA5610	Dark grey	Light grey	Right
DA5611	Dark grey	Light grey	Left
DA5612	Black	Green	Right
DA5613	Black	Green	Left
DA5614	Black	Blue	Right
DA5615	Black	Blue	Left
DA5616	Dark brown	Light brown	Right
DA5617	Dark brown	Light brown	Left
DA5618	Black	Charcoal	Right
DA5619	Black	Charcoal	Left
HHD102280	Runner & sub-frame		Right hand side
HHD102290	Runner & sub-frame		Left hand side

DA5612 / DA5613



Re-trim Kit

A Britpart XS Style re-trim kit includes:

- 1 x Fitment guide CD - This 20 minute tutorial will give you a detailed step-by-step guide to disassembling and assembling your Defender seat and information on the correct use of the included parts.
- 1 x Can of contact adhesive spray
- 1 x Squab foam
- 1 x Squab cover
- 6 x Plastic nails
- 3 x Cable ties
- 1 x Cushion foam
- 1 x Cushion cover
- 1 x Headrest cover
- 2 x Metal rods
- 1 x Rubber retainer



DA5636 Outer - Black Inner - Charcoal



DA5610 / DA5611



DA5614 / DA5615



DA5616 / DA5617



DA5618 / DA5619

BLUE

LIGHT BROWN

CHARCOAL

LIGHT GREY

GREEN

TRIM

Discovery

DA2090	Dash trim kit	Black
Discovery 1	Dash trim kit	Black
DA2091	Dash trim kit	Blue
Discovery 1	Dash trim kit	Blue
DA2096	Dash trim kit	Grey
Discovery 1	Dash trim kit	Grey
DA2098	Dash trim kit	Brown
Discovery 1	Dash trim kit	Brown

Put a stop to the dreaded dash peel!



Other

DA2002	Series	Window channel 2m length
DA2007	Series	Door rubber 30m roll



09

off road equipment

OFF-ROAD EQUIPMENT

Be prepared for the unexpected when exploring the exotic far flung corners of the globe - or even down your local greenlane.

Section contents -

Air compressors & tyre repair kit	70
Diff lockers - uprated - ARB	71
Diff lockers - uprated - Detroit	72
Fire extinguishers	72
Fuel tanks - additional	72
Hammer - emergency	73
Jacking equipment	76
Jacks - Hi-Lift	75
Jacks - Jackall	74
Jerry cans	74
Ladders	76
Land meters	76
Raised air intake - Britpart	77
Raised air intake - Safari	78
Roof tents	79

In the middle of nowhere
Picture courtesy of Cyril Mischler

AIR COMPRESSORS & TYRE REPAIR KIT

Double pump

DA2392



DA2392 - double-pump
> Air flow - 150ltr/min

DA2354 - single-pump
> Air flow - 72ltr/min

Features for both air compressors

- > 12 volt / 30 amp
- > Max. pressure - 150psi
- > Automatic cut off to prevent overheating
- > 2 metre electric hose with heavy-duty clamps
- > 10 metre air hose with heavy-duty gauge and brass fittings
- > Integrated sand tray
- > Blow moulded carrying case
- > Also great for camping and outdoor use

DA2394 NEW

Replacement cap and filter for DA2392 & DA2354

Ideal for 4x4 use!

Great features...



Heavy-duty gauge



3 nozzles

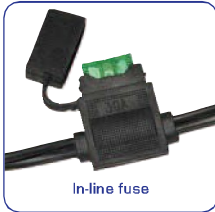

In-line fuse



Screw in air filter
DA2394



Built-in sand tray



Anti-vibration rubber feet



10m coiled hose



Heavy-duty battery clips



Blow moulded case



DA2354

Single pump

Don't get caught out with a flat tyre or two!

Pack and leave an easy to use Britpart tyre repair kit in your vehicle.*



DA2390

DA2390
Tyre repair kit in travel case

See the wheels section for more details on the tyre repair kit from Britpart.

* Recommended for off-road use only



Picture courtesy of Kristjan Kristjansson

DIFF LOCKERS - UPRATED - ARB

Air Locker locking differentials allow you to tackle the toughest terrain. As the world's premier traction aid, ARB Air Lockers keep you moving in all conditions.



ARB Diff Lockers

- > Provides 100% traction on demand without affecting on road driveability or driveline wear
- > Vastly improved traction means less reliance on momentum, thus reducing the likelihood of vehicle damage and environmental impact
- > Easy, convenient operation allows the driver to concentrate on the terrain without leaving the comfort and safety of their seat
- > Ultra durable and extremely strong - only the highest quality materials used in construction
- > Incredibly simple yet effective design that employs minimal moving parts, thereby ensuring maximum reliability
- > Thoroughly tested and proven design - trusted and used in over 80 countries around the world
- > Easy installation and maintenance - no special tools, skills or additives required
- > Two year warranty guarantees the Air Locker will be free of defects in materials



DA4191

Ultra durable and extremely strong - only the highest quality materials used in construction

Part Number	Vehicle/ Model	Axle Location	Year	Shaft Description	Shaft Diameter	Spline	Ratio
DA4191 ^{1,4}	Range Rover Classic	Front	To 1992	Rover type	28.2 (1.11")	10	3.54
DA4193 ^{1,5}	Range Rover Classic	Front	1993-1996	Rover type	31.5 (1.24")	24	3.54
DA4191 ^{1,4}	Range Rover Classic	Rear	To 1992	Rover type	28.2 (1.11")	10	3.54
DA4193 ^{1,5}	Range Rover Classic	Rear	1993-1996	Rover type	31.5 (1.24")	24	3.54
DA4344 ⁵	Range Rover P38	Front	1996-2002	Rover type, P38A	31.5 (1.24")	24	3.54
DA4344 ⁵	Range Rover P38	Rear	1996-2002	Rover type, P38A	31.5 (1.24")	24	3.54
DA4191 ¹	Discovery 1	Front	To 1993	Rover type	28.2 (1.11")	10	3.54
DA4193 ^{1,5}	Discovery 1	Front	1993-1998	Rover type	31.5 (1.24")	24	3.54
DA4191 ¹	Discovery 1	Rear	To 1993	Rover type	28.2 (1.11")	10	3.54
DA4193 ^{1,5}	Discovery 1	Rear	1993-1998	Rover type	31.5 (1.24")	24	3.54
DA4193 ^{1,5}	Discovery 2	Front	All	Rover type	31.5 (1.24")	24	3.54
DA4193 ⁶	Discovery 2	Rear	All	Rover type	31.5 (1.24")	24	3.54
DA4344 ⁶	Discovery 2	Rear	2002 on	Rover type, P38A	31.5 (1.24")	24	3.54
DA4191 ¹	Defender 110, 130	Front	1983-1993	Rover type	28.2 (1.11")	10	3.54
DA4193 ^{1,5}	Defender 110, 130	Front	1993 on	Rover type	31.5 (1.24")	24	3.54
DA4192	Defender 110, 130	Rear	1983-2002	Salisbury type	31.5 (1.24")	24	3.54
DA4193 ⁶	Defender 110, 130	Rear	2002 on	Rover type	31.5 (1.24")	24	3.54
DA4344 ⁶	Defender 110, 130	Rear	2002 on	Rover type, P38A	31.5 (1.24")	24	3.54
DA4191 ¹	Defender 90	Front	1984-1993	Rover type	28.2 (1.11")	10	3.54
DA4193 ^{1,5}	Defender 90	Front	1993 on	Rover type	31.5 (1.24")	24	3.54
DA4191 ¹	Defender 90	Rear ^c	1983-1993	Rover type, 4 cyl. petrol & diesel engines	28.2 (1.11")	10	3.54
DA4193 ^{1,6}	Defender 90	Rear	1993 on	Rover type	31.5 (1.24")	24	3.54
DA4344 ⁶	Defender 90	Rear	2002 on	Rover type, P38A	31.5 (1.24")	24	3.54
DA4191 ^{2,3}	Series 1, Series 2, Series 3	Front	1948-1985	Rover type	28.2 (1.11")	10	4.7
DA4191 ^{2,3}	Series 1, Series 2, Series 3	Rear	1948-1985	Rover type	28.2 (1.11")	10	4.7
DA4345	Series 1, Series 2, Series 3	Rear	1948-1985	Salisbury type	31.5 (1.24")	24	4.7

Notes: 1 If vehicle was manufactured during 1993, check spline count. 2 Air Locker not available for vehicles equipped with high load option. 3 Ring gear spacer required. Longer ring gear bolts (not supplied) are also necessary - (Land Rover part no. 576521). 4 When an DA4191 Air Locker is to be installed in Range Rovers manufactured prior to 1980 (approx.), special carrier bearings (No. K11300/K11162) may also be necessary - Land Rover part no. RTC3426. 5 Some vehicles have crown wheel bolts which cannot be reused and must be replaced. Consult service manual. 6 P38A is most commonly found in traction control equipped vehicles. Identify P38A type diff by large 205mm [8.07"] flange diameter. P38A was not used on North American delivered Discoverys - use DA4193.

ARB Compressor

- > Designed for Air Locker use
- > High flow, compact 12v compressor
- > Sealed for moisture and dust resistance
- > Hard anodised cylinder bore and Teflon impregnated carbon fibre piston seal for reduced friction and maximum trouble free life
- > Heavy-duty maxi-fuse equipped for professional in-line circuit protection
- > Quality components for quiet operation and extra long life
- > Anodised mounting brackets dissipates motor heat and allows compressor to be repositioned 180°
- > Constructed entirely of lightweight, high strength engineering grade materials
- > Over-pressure safety valve equipped
- > Motor is internally thermal protected against extreme temperature damage



DA4190



DA4194



SWITCH COVERS

DA4190 Compressor assembly 12 volt

DA4194 Dash switch for compressor and lockers

NEW Dash switch covers - DA4360 - Front locker; DA4361 - Rear locker; DA4362 - Compressor

DIFF LOCKERS - UPRATED - DETROIT

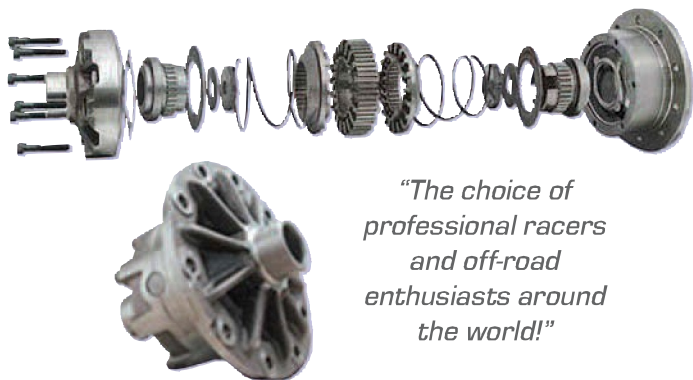

"The choice of professional racers and off-road enthusiasts around the world!"

Detroit Locker

- > 100% locking differential
- > Legendary traction
- > Ultimate performance

The legendary Detroit Locker began the revolution in performance differentials and still leads the industry today as an Eaton brand. The Detroit Locker is the most durable and dependable locking differential available. The Detroit Locker maximises traction by delivering 100% of the torque to both drive wheels. It is engineered to keep both wheels in a constant drive mode, and has the ability to automatically allow wheel speed differentiation when required. No other performance differential has the reputation for delivering traction in mud, snow, rocks and on the track. The choice of professional racers and off-road enthusiasts around the world! The durability of the Detroit Locker is unmatched!

DA5700	Series 3/Defender/Discovery 1/Range Rover Classic	Detroit Locker	24 spline	Rear
DA5701	Series 3/Defender/Discovery 1/Range Rover Classic	Detroit Locker	10 spline	Rear
DA5704	Defender - Salisbury axle	Detroit Locker	24 spline	Rear

Detroit Truetrac

- > Smooth operation
- > Performs open until needed
- > Fully automatic limited slip

Note - when fitting to non-metric diff casings 2 x RTC3095 bearings are required

The Detroit Truetrac was the first helical gear differential ever introduced into the automotive aftermarket as an Eaton brand. It remains the leading helical gear-type limited slip differential in the industry. Detroit Truetrac's proven helical gear design eliminates the need for wearable parts, resulting in maintenance free traction. Recognised not only for its toughness but also its smooth and quiet operation. Engineered to work efficiently in front and rear axles, semi-floating (C-clip axles) and transfer cases. Power transfer is so smooth, it literally goes unnoticed by the driver - even in front wheel drive axles. Proven design, low cost and effective performance, all make the Detroit Truetrac limited slip differential the ideal choice for a wide variety of vehicle applications. No maintenance - just traction!

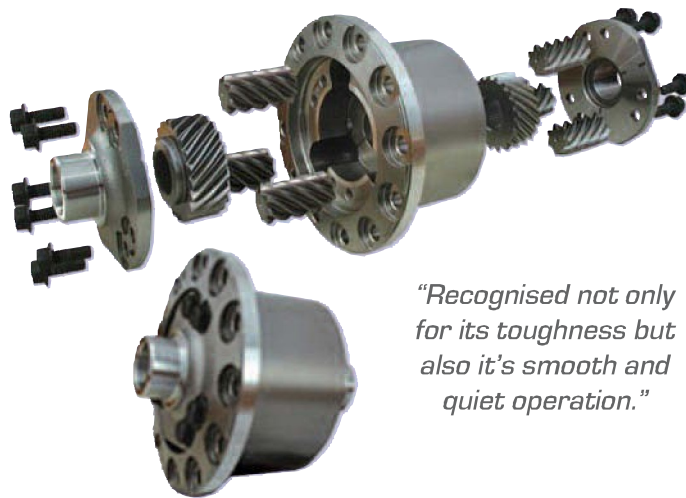

"Recognised not only for its toughness but also its smooth and quiet operation."

DA5705	Series 3/Defender/Discovery 1/Range Rover Classic	Detroit Truetrac	10 spline	Rear
DA5706	Series 3/Defender/Discovery 1/Discovery 2/Range Rover Classic	Detroit Truetrac	10 spline	Front
DA5709	Series 3/Defender/Discovery 1/Discovery 2/Range Rover Classic	Detroit Truetrac	24 spline	Rear
DA5710	Series 3/Defender/Discovery 1/Discovery 2/Range Rover Classic	Detroit Truetrac	24 spline	Front
DA5711	Defender - Salisbury axle	Detroit Truetrac	24 spline	Rear

FIRE EXTINGUISHERS



STC8529AA

- > 1kg kit
- > One-handed operation fire extinguisher
- > High rating
- > Checkable & re-chargeable
- > With crash-tested bracket
- > Attractive design
- > Controlled discharge



STC8138AB

- > 2kg kit
- > Long-life - 100% polyester resin coated fire extinguisher
- > Safe handling & crash proof fastening
- > Readiness to operate displayed by manometer
- > Precision brass valve

FUEL TANKS - ADDITIONAL

DA4545



DA4545 NEW

Defender 110 up to 1999 (metal tank, pre Td5 models)
Rear arch spare fuel tank - right hand side - 45 litres
> Supplied with all the necessary fittings to install and use

DA4546

The best way of getting more fuel in to the vehicle without using valuable space or complex pumping systems

DA4546 NEW

Defender 110 after 1999 (plastic tank, Td5 and the new Td4 models)
Rear arch spare fuel tank - right hand side - 45 litres
> Supplied with all the necessary fittings as well as a replacement filler neck and specifically engineered bulkhead fitting for the balance pipe, having these makes the fitting of the tank quicker and easier as well as it working better too.

Note - Both tanks are not suitable for Defender 130

HAMMER - EMERGENCY

DA6500

Life Hammer - The Original

- > Double-sided steel hammer for shattering windows quickly and easily for a safe and quick exit from any vehicle.
- > Razor sharp blade cuts through seatbelts to ease escape.
- > Fluorescent button allows hammer to be located in the dark.
- > Installation mounting bracket ensures hammer is accessible when you most need it.



DA6500



Picture courtesy of Daniel Taw

JERRY CANS

"Don't get caught short!"



DA2166

- DA2166**
Jerry can
20ltr
- DA2170**
Jerry can
20ltr stainless steel
- DA2171**
Jerry can
10ltr stainless steel
- DA2172**
Jerry can spout
stainless steel
- DA2182**
Jerry can holder for
20ltr cans



DA2170



DA2171



DA2172



DA2182

Jerry can not included

JACKS - JACKALL

8,000lbs capacity Jacks - Versatile! Rugged! Pow'R-ful!



Built with a patented 'Safety Link', the Maasdam Jackall is the 'Jack with More! Larger base for greater stability. 'Safety Link' mechanism that prevents abuse, misuse and makes operations safer. Jacks come with a lifetime warranty and are built to current ANSI/ASME specifications. When safety and dependability matter most, continue to rely on Jackall.

Features

- > Patented "safety link" mechanism
- > Heavy ribbed, extra large base
- > Cast components
- > Hot roll-formed, alloy steel beam
- > Steel handle locks against beam
- > Powder coated through and through

Benefits

- > Prevents abuse and misuse
- > Provides strength and greater load stability
- > Assures long life, trouble free operation
- > Strong and reliable
- > For convenient storage
- > Reduces scratching, greater corrosive resistance

DA3121

DA3122

DA3121	48" Jack [4ft]	DA3122	60" Jack [5ft]
DA3130	Top clamp	DA4058	Maintenance kit
DA4059	Jacking point adaptor	DA4061	Mounting kit jack rack



DA3130



DA4058



DA4059



DA4061

Patented "Safety Link" pitman mechanism prevents abuse and misuse. "Safety Link" yields when capacity exceeded — load can no longer be lifted. Operational safety at its best.

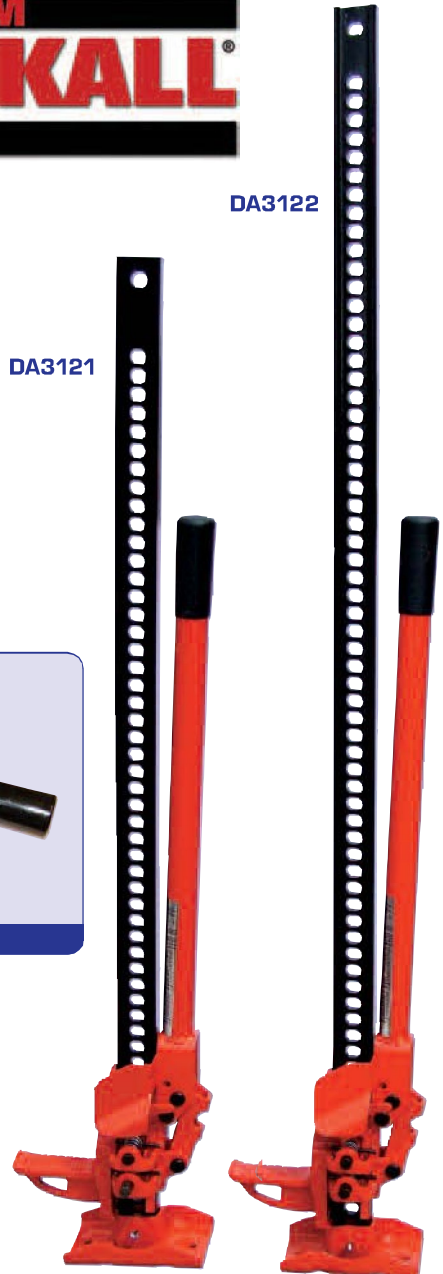

JACKS - HI-LIFT



rugged,
highly versatile jack

DA3120

- DA2243 48" Jack (4ft)
- DA3120 60" Jack (5ft)

DA2243

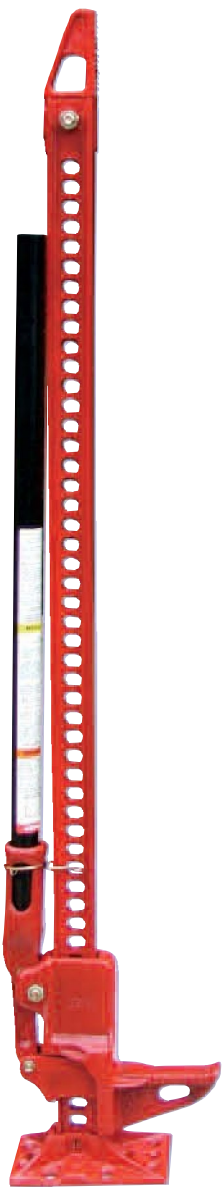

The Hi-Lift jack is a rugged, highly versatile jack that puts you in command of situations requiring lifting, pushing, pulling, winching, and clamping. Although light in weight and easy to manoeuvre, the Hi-Lift jack offers a rated lifting capacity of 2^{1/3} tons (2,114kgs).

Specifications

- > Approximate weight: 30lbs (14 kg)
- > 4,660lbs (2,113kgs) rated capacity
- > Climbing pins of specially processed steel with 125,000psi tensile strength and 100,000psi yield
- > Steel bar is manufactured of specially rolled extra high carbon steel with 80,000lbs minimum tensile and carbon 0.69 to 0.82
- > Steel handle of 14-gauge high-yield structural tubing with minimum yield of 55,000psi 1^{5/16}" diameter x 30" long

Features

- > Every jack comes complete with an adjustable top clam clevis for use in clamping and winching
- > For speedy disengaging, lifting unity automatically drops away when load is removed
- > 4^{1/2}" (11cm) long lifting nose for positive contact with load
- > Safety bolt is designed to shear at 7,000lbs. (3,175 kg)
- > Steel bar can be reversed for extra long life
- > Low pickup of 4^{1/2}" (11cm)
- > 28" square base plate

DA2248



DA2243EYE



DA2174



DA4355



DA4350



DA4351



DA4353



DA4352



Accessories

DA2174	Off-road base	Alleviates jack sinkage on soft surfaces. Suits all models.
DA2243EYE	Jacking eye	Spare jacking eye.
DA2248	Fix-it-kit	The maintenance kit contains all the key components for servicing all Hi-Lift jacks.
DA4350	4XRAC	Heavy-duty mounting system for the serious off-roader.
DA4351	Loc-Rac	Conveniently mounts and locks your Hi-Lift jack. Includes lock and suits all models.
DA4352	Jack protector	The jack protector vinyl bag protects your jack from the elements. One size fits all.
DA4353	Lift mate	Designed to provide a lift point from most wheels for quick and easy lifting. The lifting capacity is 5,000lbs/2,273kgs.
DA4354	Off-road kit	The Hi-Lift winching kit includes a winch attachment, winch tensioner, tree strap, d-ring shackle, Hi-Lift gloves and gear bag. Winch time is reduced significantly using the winch attachment and tensioner together.
DA4355	Bumper lift	Designed to fit curved steel bumpers. The rugged design of the bumper lift has a lifting capacity of 3,000lbs/1,361kgs.
DA4356 NEW	Neoprene jack cover	This jack cover offers a level of mud and dirt protection for the main lifting mechanism of the jack when not in use. It zips on easily over the foot of the jack and provides a tight fit.
	Adjustable tube jack mount	Designed for mounting a Hi-Lift® jack to round and square tube bumpers, bull bars, roll cages and roof racks, this accessory allows for easy and adjustable mounting on tubes from 1" to 3" in diameter.
DA4357 NEW	Small set	Is for use on round tubes from 1 to 2" in diameter, which works on many roof racks. It can also be used on ATV/UTV bars, bumpers and roll cages
DA4358 NEW	Large set	Is intended for round tubes from 2 to 3" in diameter that will work on most vehicle bull bars and roll cages

JACKING EQUIPMENT



DA2244

Anti-rattle jack clamps

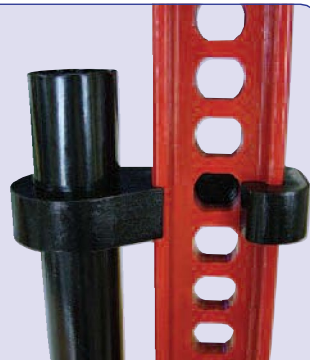

DA3153 / DA3154 / DA3155

DA5607

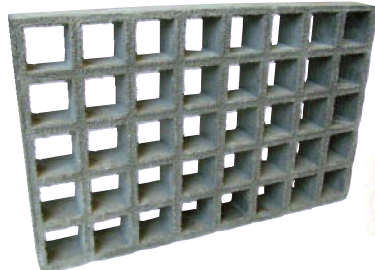

ANR4489 (kit), KAJ100570 & KAH000050 (individual)

ANR4489	Jack and handle (KAJ100570 & KAH000050)	
KAJ100570	Standard bottle jack	
KAH000050	Handle for KAJ100570 Note - Defender only	
DA2244	Jacking point adaptor	
DA3153	Anti-rattle jack clamp	Red
DA3154	Anti-rattle jack clamp	Black
DA3155	Anti-rattle jack clamp	Yellow
DA5607	Jack base - 310 x 195 x 38mm	Grey



LADDERS



DA2231



DA5601

DA2231	Sandtrack 4mm aluminium	1,500 long x 390mm wide - pair	
DA5600	Fibreglass bridging ladders	1,220 long x 260 wide x 50mm deep - pair	Grey with gritted surface for extra traction
DA5601	Fibreglass bridging ladders	1,220 long x 270 wide x 38mm deep - pair	Grey with gritted surface for extra traction

LAND METERS



DA1003

- > Independent twin meter
- > Convenient for seeing the pitching and rolling of the vehicle body or terrain
- > Transparent illumination for easy-to-see readings at night



DA1004

DA1003	Double incline land meter
	Black finish
DA1004	Double incline land meter
	Carbon effect finish

RAISED AIR INTAKES - BRITPART

If your likely to be driving your Land Rover in circumstances which could mean wading deep water or driving in very dusty conditions then you should consider fitting a raised air intake to your vehicle. This version from Britpart is a classic mushroom-top snorkel for Defender. Featuring heavy-duty metal pipe work, cyclone pre-cleaner and a durable attractive matt black finish.

DA2225	Defender - 300Tdi/Td5
PHD500340	Defender - 2007 onwards
NRC6920	Raised air intake cleaner



NRC6920



DA2225



Be prepared for the **unexpected**
with off-road equipment from **Britpart!**

RAISED AIR INTAKES - SAFARI



Pioneered in Australia in the early 1980's, Safari Snorkels were born out of a need to protect 4WD engines from the hazards of dust and water commonly encountered in touring and off road applications. Safari snorkels are manufactured to the highest standards in durable, UV stable, cross linked polyethylene material, using stainless

steel hardware where appropriate. Each system includes quality fixtures and fittings, which offer superior sealing, presentation and long-term durability.

In arguably the best, if not toughest environment, Safari Snorkel Systems are thoroughly researched, tested and tooled for each model of Land Rover. The Safari Snorkel delivers a continuous and cooler supply of air for maximum engine performance. It is positively sealed as well to ensure the best protection against deep water crossings and dust.



DA3024



DA3069



DA3021

Defender

DA3024 200Tdi - 1990 - 1994	LHS
DA3025 V8 1984 - 1994	RHS
DA3026 300Tdi - 1994 - 1999	RHS
DA3027 Td5 - 1999 onwards - right hand drive	RHS
DA3027LH Td5 - 1999 onwards - left hand drive	RHS
DA3069 2007 onwards	RHS
DA2374 Stainless steel air ram grille (shown attached to air ram - grille only) Note - Will not fit DA3069 snorkel	
DA3141 3" replacement air ram for DA3024	
DA3142 3 1/2" replacement air ram for DA3025, DA3026, DA3027, DA3027LH Note - Fitment from seated internal view - RHS - right hand side and LHS - left hand side.	

Discovery

DA3015 Discovery 1 - 200Tdi - 1990-1994	LHS
DA3018 Discovery 1 - V8 1990 - 1994	LHS
DA3020 Discovery 1 - 300Tdi (none EGR)/V8 - 1994-1999 - Non ABS	LHS
DA3022 Discovery 1 - 300Tdi (none EGR)/V8 - 1994-1999 - ABS	LHS
DA3023 Discovery 2 - Td5/V8 - 1999 on	LHS
DA3021 Discovery 3 - TdV6 SE	RHS
DA2374 Stainless steel air ram grille (shown attached to air ram - grille only)	
DA3141 3" replacement air ram for DA3015, DA3018, DA3020, DA3022, DA3023	
DA3142 3 1/2" replacement air ram for DA3021 Note - Fitment from seated internal view - RHS - right hand side and LHS - left hand side	



DA2374



DA3141 / DA3142

For more Safari Snorkel pictures visit -
www.britpart.com/safari

Safari snorkels are manufactured to the highest standards in durable, UV stable, cross linked polyethylene material

ROOF TENTS

Britpart are proud to be the sole European distributor for Echo roof top tents. They are the only heavy-duty tents available with convenient one-piece pitching and self-support.

Roof Top Tents

- > Manufactured from washable UV-varnished PVC canvas with welded seams.
- > 100% waterproof and they have been tested to withstand extreme weather conditions.
- > Ample ventilation is provided by having windows and doors on each side and each is covered with insect netting.
- > Maintenance-free floor - constructed from lightweight aluminium.
- > Comfort is ensured with a 60mm two-layer laminated foam mattress.
- > Removable two-section ladder provides easy access.
- > Quick and easy to store with the fold-up bungee system with dust cover.

'T' Top Tents

The same superior quality design as the above Roof Top Tents but with a unique designed versatile tent that allows access into the main rooftop from inside the tent. The bottom tent has 4 roll-up side panels which could be used as awnings and as doors to access your vehicle from inside the tent. Easy to open and close, no maintenance.



DA2501 - with add-on room not fitted

DA2500

Roof top tent

Including condensation sheet

Open - 1,300 x 2,400mm;

Closed - 1,300 x 1,200mm

DA2501

'T' Top tent

Including add-on room & condensation sheet

Open - 1,300 x 2,600mm;

Closed - 1,300 x 1,200mm



They are the only **heavy-duty** tents available with convenient one-piece pitching and self-support.



DA2501 - with add-on room fitted



DA2500



DA2501 - inside

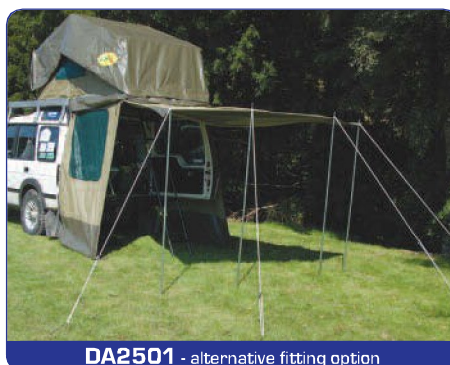

DA2501 - alternative fitting option



DA2501 - alternative fitting option



Picture courtesy of Ian Huime

10

winching equipment

WINCHING EQUIPMENT

Never get stuck again with a Britpart winch and winching accessories - we've all you need to get out of that sticky situation.

Section contents -

Batteries - Lucas	82
Batteries - Optima	82
Britpart winch - DB12000i	83
Britpart winch - DB9500i	83
Britpart winch - DB9000C	84
Britpart winch - DB8000	84
Britpart winch - DB6000	85
Britpart winch - DB2000	85
Winch bumper kits	86
Winch bumpers	87
Winch spare parts	88
Winching accessories	89 - 91
Winching accessory kits	91

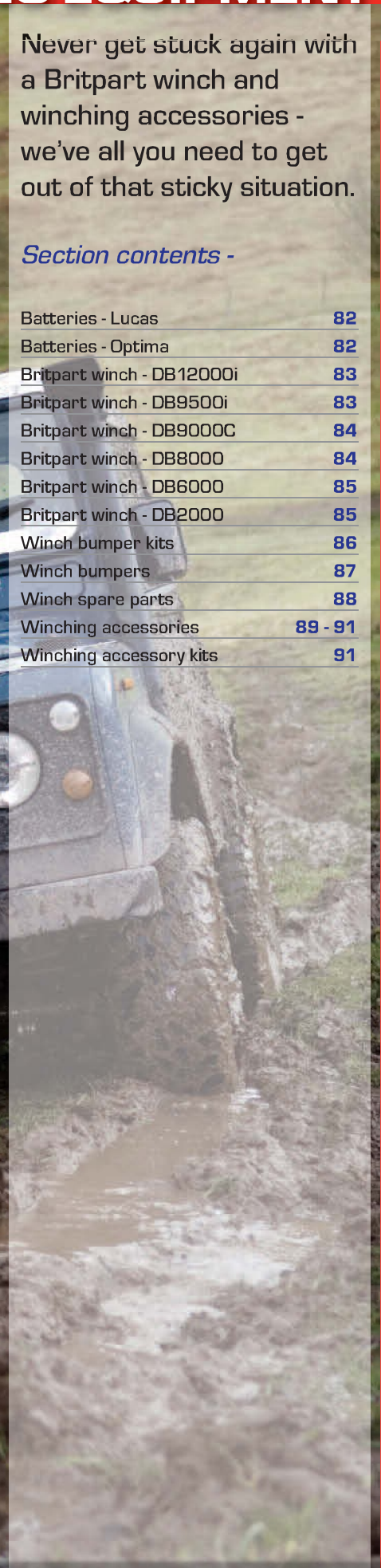

BATTERIES - LUCAS NEW

Lucas batteries offer:

- > Original equipment (OE) quality standards, giving assurance that the batteries will not let the user down
- > Batteries are manufactured on the same equipment as OE batteries and use the same components to give a consistent quality and performance
- > The confidence of the Lucas brand
- > Lucas batteries are recyclable, helping to protect the environment
- > 3 Year warranty

	Voltage	Capacity	Cold Cranking Amps (CCA)
STC4757	12v	70Ah	500
STC8587	12v	110Ah	750
YGD000271	12v	110Ah	920
YGD100860	12v	115Ah	900
YGD500100	12v	70Ah	750
YGD500130	12v	95Ah	855
YGD500190	12v	80Ah	770



YGD500100

BATTERIES - OPTIMA



DB1018

With its patented *Spiralcell*[®] Technology, Optima batteries offer 15 times the vibration resistance and up to twice the life of ordinary batteries. The Optima is like no other battery found in today's market. Optima's unique patented *Spiralcell*[®] design offers the best technology by providing a strong and clean power source that far surpasses any of today's traditional lead acid batteries. With Optima as your choice, you can count on a longer lasting battery.



DB1020



> Twice the life of ordinary batteries

> 15 times the vibration resistance

Yellow Top

Demand more from your vehicle? Then get more from your battery. Optima Yellow Top batteries are made for the extremes. If your vehicle is designed to take the abuse of off-road driving, you need increased performance and reliability from your battery. Optima batteries combine patented *Spiralcell*[®] Technology to deliver that performance. The deep cycle characteristics of this technology coupled with its extreme resistance to vibration provides performance vehicles with the repetitive power they need, packaged in a spill-proof compact design.

If your vehicle is fitted with high drain accessories such as additional lighting, tracking devices, ICE systems, winches, hydraulics etc, then this ultimately demands more from your battery. Optima Yellow Top batteries provide the extra performance and deep cycling capability that your vehicle demands.

Voltage - 12v Capacity - 55Ah Cold Cranking Amps (CCA) - 765

DB1018	Yellow Top	Top terminals
DB1020	Yellow Top	Side terminals

Red Top

Optima Red Top batteries are built to withstand the abuse 4x4's experience on and off-road. *Spiralcell*[®] Technology immobilises the internal components of the battery, enabling Optima batteries to withstand incredible amounts of vibration.

Vehicles modified for improved engine performance demand more from a battery. Optima batteries withstand the high engine bay temperatures associated with these performance vehicles. The sealed construction makes the battery spill-proof, even if you install it on its side! This prevents external gassing and leaking which can damage engine components and reduce battery performance.

If your battery is used in applications that demand extra reliability endurance and performance, or if you just take pride in getting the best performance out of your vehicle, Optima Red Top batteries deliver the performance you demand.

Voltage - 12v Capacity - 50Ah Cold Cranking Amps (CCA) - 815

DB1019	Red Top	Top terminals
DB1021	Red Top	Side terminals



DB1019



DB1021

BRITPART WINCH - DB12000i - 12 & 24 VOLT

Features

- > 3.6Kw (4.8Hp) heavy duty series wound DC motor
- > Weather and dustproof contactor controls for longer life and improved amperage draw
- > Planetary gear system for fast line speed
- > Automatic load-holding brake
- > Free spooling
- > Power in and power out
- > Low electric current
- > Hardened drum
- > Thermal overload protection

Don't forget a DB1014!
When fitting a winch to a Defender don't forget to order the extended winch wiring kit with cut-off switch.

Specification

- > Rated line pull - single line 5,443kgs 12,000lbs
- > Gear reduction ratio 294:1
- > Motor [series wound] 3.6Kw 4.8Hp
- > Drum size [D x L] 63 x 228mm 2 1/2" x 9"
- > Cable supplied 9.53mm x 30.5m 3/8" x 100'
(Galvanised aircraft cable with minimum break force 14,400lbs)
- > Overall dimension [L x W x H] 548 x 160 x 254mm 21.57 x 6.3 x 10"
- > Net weight 41.7kgs 92.0lbs
- > Mounting bolt pattern 254 x 114.3mm 10 x 4 1/2"

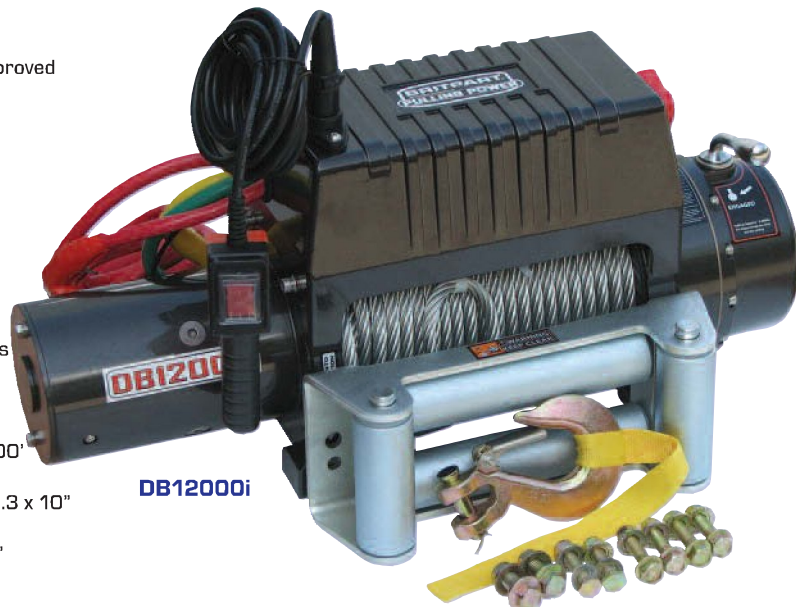

DB12000i

Performance of 1st Layer

Line Pull		Line Speed				Motor Current	
		12 volt		24 volt		12 volt	24 volt
Lbs	Kgs	Fpm	Mpm	Fpm	Mpm	Amp	Amp
0	0	14.60	4.45	16.40	5.00	90	58
2,000	907	12.81	3.90	14.43	4.40	145	95
4,000	1,814	9.68	2.95	12.46	3.80	185	120
6,000	2,722	7.90	2.41	10.83	3.30	230	160
8,000	3,629	7.07	2.15	9.50	2.90	270	190
10,000	4,536	5.06	1.54	7.87	2.40	315	230
12,000	5,443	4.45	1.36	5.90	1.80	375	280

DB12000i Britpart Pulling Power 12,000lbs 12 volt winch
DB12000i24 Britpart Pulling Power 12,000lbs 24 volt winch

Line Pull & Cable Capacity by Layer

Cable Layer	Rated Line Pull		Cable Capacity	
	Lbs	Kgs	Feet	Meters
1	12,000	5,443	15	5.0
2	10,200	4,627	38	11.5
3	8,400	3,810	64	19.5
4	7,300	3,310	95	29.0
5	6,500	2,948	100	30.5

BRITPART WINCH - DB9500i - 12 & 24 VOLT

Features

- > 3.6Kw (4.8Hp) heavy duty series wound DC motor
- > Weather and dustproof contactor controls for longer life and improved amperage draw
- > Hardened drum
- > Planetary gear system for fast line speed
- > Free spooling
- > Automatic load-holding brake
- > Low electric current
- > Power in and power out
- > Thermal overload protection

Don't forget a DB1014!
When fitting a winch to a Defender don't forget to order the extended winch wiring kit with cut-off switch.

Specification

- > Rated line pull - single line 4,309kgs 9,500lbs
- > Gear reduction ratio 212:1
- > Motor [series wound] 3.6Kw 4.8Hp
- > Drum size [D x L] 63 x 228mm 2 1/2" x 9"
- > Cable supplied 9.53mm x 30.5m 3/8" x 100'
(Galvanised aircraft cable with minimum break force 14,400lbs)
- > Overall dimension [L x W x H] 548 x 160 x 254mm 21.57 x 6.3 x 10"
- > Net weight 41.7kgs 92.0lbs
- > Mounting bolt pattern 254 x 114.3mm 10 x 4 1/2"



DB9500i

Performance of 1st Layer

Line Pull		Line Speed				Motor Current	
		12 volt		24 volt		12 volt	24 volt
Lbs	Kgs	Fpm	Mpm	Fpm	Mpm	Amp	Amp
0	0	18.70	5.70	21.30	6.50	85	58
2,000	907	13.12	4.00	16.70	5.10	150	110
4,000	1,814	10.50	3.20	13.12	4.00	210	135
6,000	2,722	7.90	2.41	10.17	3.10	270	185
8,000	3,629	5.91	1.80	7.71	2.35	320	220
9,500	4,309	4.32	1.32	5.90	1.80	365	240

DB9500i Britpart Pulling Power 9,500lbs 12 volt winch
DB9500i24 Britpart Pulling Power 9,500lbs 24 volt winch

Line Pull & Cable Capacity by Layer

Cable Layer	Rated Line Pull		Cable Capacity	
	Lbs	Kgs	Feet	Meters
1	9,500	4,309	15	5.0
2	7,500	3,402	38	11.5
3	6,200	2,812	64	19.5
4	5,300	2,404	95	29.0
5	4,630	2,100	100	30.5

BRITPART WINCH - DB9000C



DB9000C

DB9000C Britpart Pulling Power 9,000lbs 12 volt winch

Features

- > 3.3Kw (4.5Hp) permanent magnet motor
- > Dustproof contactor controls for longer life and improved amperage draw
- > Low electric current
- > Planetary gear system for fast line speed
- > Free spooling
- > Automatic load-holding brake
- > Power in and power out
- > Hardened drum

Don't forget a DB1014!
When fitting a winch to a Defender don't forget to order the extended winch wiring kit with cut-off switch.

Specification

- > Rated line pull - single line 4,082kgs 9,000lbs
- > Gear reduction ratio 212:1
- > Motor [permanent magnet] 3.3Kw 4.5Hp
- > Drum size [D x L] 63 x 228mm 2 1/2" x 9"
- > Cable supplied 9.53mm x 30.5m 3/8" x 100'
(Aircraft cable with minimum break force 14,400lbs)
- > Overall dimension [L x W x H] 560 x 160 x 280mm 22 x 6.3 x 11"
- > Net weight 38.0kgs 84.0lbs
- > Mounting bolt pattern 254 x 114.3mm 10 x 4 1/2"

Performance of 1st Layer

Line Pull		Line Speed		Motor Current
Lbs	Kgs	Fpm	Mpm	Amp
0	0	13.0	4.0	30
4,000	1,814	7.5	2.3	130
6,000	2,722	6.3	1.9	180
8,000	3,629	5.0	1.5	240
9,000	4,082	4.3	1.3	300

Line Pull & Cable Capacity by Layer

Cable Layer	Rated Line Pull		Cable Capacity	
	Lbs	Kgs	Feet	Meters
1	9,000	4,082	15	5.0
2	7,300	3,311	38	11.5
3	6,200	2,812	64	19.5
4	5,400	2,449	95	29.0
5	4,200	1,905	100	30.5

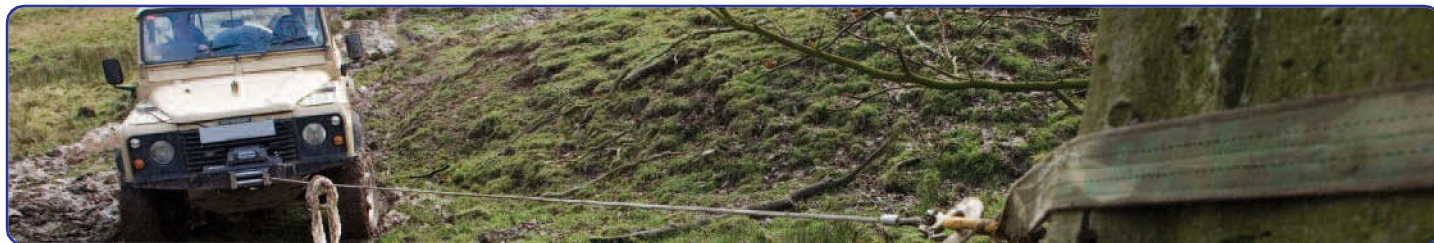

BRITPART WINCH - DB8000



DB8000

DB8000 Britpart Pulling Power 8,000lbs 12 volt winch

Features

- > 3.0Kw (4.1Hp) heavy duty electric permanent magnetic DC motor
- > Weather and dustproof contactor controls for longer life and improved amperage draw
- > Hardened drum
- > Planetary gear system for fast line speed
- > Free spooling
- > Automatic load-holding brake
- > Low electric current
- > Power in and power out

Don't forget a DB1014!
When fitting a winch to a Defender don't forget to order the extended winch wiring kit with cut-off switch.

Specification

- > Rated line pull - single line 3,632kgs 8,000lbs
- > Gear reduction ratio 210:1
- > Motor [permanent magnet] 3.0Kw 4.1Hp
- > Drum size [D x L] 63 x 228mm 2 1/2" x 9"
- > Cable supplied 9.53mm x 30.5m 3/8" x 100'
(Galvanised aircraft cable with minimum break force 14,400lbs)
- > Overall dimension [L x W x H] 564 x 179 x 295mm 22.2 x 7.0 x 11.6"
- > Net weight 36kgs 80lbs
- > Mounting bolt pattern 254 x 114.3mm 10 x 4 1/2"

Performance of 1st Layer

Line Pull		Line Speed		Motor Current
Lbs	Kgs	Fpm	Mpm	Amp
0	0	8.2	2.5	35
2,000	900	7.8	2.4	100
4,000	1,810	7.2	2.2	180
6,000	2,710	6.5	2.0	230
8,000	3,620	5.0	1.5	300

Line Pull & Cable Capacity by Layer

Cable Layer	Rated Line Pull		Cable Capacity	
	Lbs	Kgs	Feet	Meters
1	8,000	3,620	15	5.0
2	6,335	2,876	38	11.5
3	5,243	2,380	64	19.5
4	4,473	2,030	95	29.0
5	3,900	1,770	100	30.5

BRITPART WINCH - DB6000

Features

- > 2.7Kw (3.6Hp) permanent magnet motor
- > Dustproof contactor controls for longer life and improved amperage draw
- > Planetary gear system for fast line speed
- > Free spooling
- > Low electric current
- > Automatic load-holding brake
- > Power in and power out

Don't forget a DB1014!
When fitting a winch to a Defender don't forget to order the extended winch wiring kit with cut-off switch.

Specification

- > Rated line pull - single line 2,724kgs 6,000lbs
- > Gear reduction ratio 210:1
- > Motor (permanent magnet) 2.7Kw 3.6Hp
- > Drum size (D x L) 63 x 140mm 2 1/2" x 5.51"
- > Cable supplied 7.94mm x 26m 5/16" x 85'
(Aircraft cable with minimum break force 10,000lbs)
- > Dimensions (L x W x H) 438 x 158 x 185mm 17.24 x 6.22 x 7.28"
- > Net weight 31.8kgs 70.0lbs
- > Mounting bolt pattern 166 x 114.3mm 6.535 x 4 1/2"



DB6000

DB6000 Britpart Pulling Power 6,000lbs 12 volt winch

Performance of 1st Layer

Line Pull		Line Speed		Motor Current
Lbs	Kgs	Fpm	Mpm	Amp
0	0	15.0	4.6	30
1,000	454	11.5	3.5	80
3,000	1,361	9.0	2.7	120
5,000	2,268	7.0	2.0	170
6,000	2,722	4.9	1.5	210

Line Pull & Cable Capacity by Layer

Cable Layer	Rated Line Pull		Cable Capacity	
	Lbs	Kgs	Feet	Meters
1	6,000	2,722	12.7	3.87
2	5,000	2,268	27.5	8.38
3	4,250	1,928	44.0	13.41
4	3,720	1,687	64.0	19.51
5	3,330	1,497	85.0	25.91



Get to where you want to go!

BRITPART WINCH - DB2000

Features

- > 1.0Kw (1.5Hp) heavy duty electric permanent magnetic motor
- > Planetary gear system for fast line speed
- > Free spooling
- > Power in and power out
- > Low electric current
- > Tension plate to prevent rope entanglement

Specification

- > Rated line pull - single line 907kgs 2,000lbs
- > Gear reduction ratio 153:1
- > Motor (permanent magnet) 1.0Kw 1.5Hp
- > Drum size (D x L) 32 x 71mm 1.26 x 2.8"
- > Cable supplied - 4mm x 15.2m 5/32" x 50'
(minimum break force 4,000lbs)
- > Dimension (L x W x H) 320 x 105 x 110.5mm 12.6 x 4.13 x 4.35"
- > Net weight 6.6kgs 14.6lbs
- > Mounting bolt pattern 48 x 76mm 1.89 x 3"



DB2000

DB2000 Britpart Pulling Power 2,000lbs 12 volt winch

Performance of 1st Layer

Line Pull		Line Speed		Motor Current
Lbs	Kgs	Fpm	Mpm	Amp
0	0	14.0	4.3	14
1,000	454	9.0	2.7	60
1,500	680	7.5	2.3	90
2,000	907	5.9	1.8	115

Line Pull & Cable Capacity by Layer

Cable Layer	Rated Line Pull		Cable Capacity	
	Lbs	Kgs	Feet	Meters
1	2,000	907	6	1.8
2	1,636	742	13	4.0
3	1,385	628	22	6.7
4	1,200	544	33	10.0
5	1,059	480	44	13.4
6	947	430	50	15.2

WINCH BUMPER KITS



The only kits you need to get winching...

DB1310	Defender - non air-con	Standard bumper	DB9500i winch	Extended wiring kit including safety cut-off switch
DB1313	Defender - non air-con	Standard bumper	DB12000i winch	Extended wiring kit including safety cut-off switch
DB1319	Defender - non air-con	Tubular bumper	DB12000i winch	Extended wiring kit including safety cut-off switch
DB1321	Defender - air-con	Tubular bumper	DB12000i winch	Extended wiring kit including safety cut-off switch
DB1320	Discovery 1	Tubular bumper	DB12000i winch	
DB1324	Discovery 1/Range Rover Classic	Heavy-duty bumper	DB9500i winch	
DB1325	Discovery 1/Range Rover Classic	Heavy-duty bumper	DB12000i winch	



DB1320



DB1324 / DB1325



WINCH BUMPERS

DA5609

- > Stylish tubular steel space-frame construction for strength to fit Defender with air con
- > Suitable for DB12000i, DB9500i, DB9000C & DB8000 winches
- > Extremely close fitting for maximum approach angle
- > Compatible with many steering guards
- > Built in high-lift jacking points
- > Integral rock guard
- > Supplied with full fitting

DA5620

- > Heavy duty steel winch bumper for Defender
- > Suitable for DB12000i, DB9500i & DB9000C winches

DA5622

- > Stylish tubular steel space-frame construction for strength to fit Defender - no air con
- > Suitable for DB12000i, DB9500i, DB9000C & DB8000 winches
- > Extremely close fitting for maximum approach angle
- > Compatible with many steering guards
- > Built in high-lift jacking points
- > Integral rock guard
- > Supplied with full fitting

DA5623

- > Heavy duty steel winch bumper for Defender with air con
- > Suitable for DB12000i, DB9500i & DB9000C winches

DA5643

- > Heavy duty steel winch bumper for Defender with air-con
- > Suitable for Warn 9000 and 9.5 Series winches

DA5604

- > Stylish tubular steel space-frame construction for strength to fit Discovery 1
- > Suitable for DB12000i, DB9500i, DB9000C & DB8000 winches
- > Extremely close fitting for maximum approach angle
- > Compatible with many steering guards
- > Built in high-lift jacking points
- > Integral rock guard
- > Supplied with full fitting

DA5621

- > Heavy duty steel winch bumper for Discovery 1 & Range Rover Classic
- Note** - not suitable for V8 automatic vehicles
- > Suitable for DB12000i, DB9500i, DB9000C & DB8000 winches



Winch and A bar not included

DA5620

DA5609



DA5622

DA5623

DA5643

DA5604

DA5621

Winch not included

A range of winch bumpers to suit your vehicle!



WINCH SPARE PARTS



DB1301



DB1302



DB1303



DB1304



DB1307



DB1326



DB1328



DB1330

Part	Winch				
	DB12000i	DB9500i	DB9000C	DB8000	DB6000
Winch motor	DB1300	DB1300	DB1332	DB1301	DB1337
Solenoid assembly	DB1303	DB1303	DB1302	DB1302	DB1336
Brake service kit	DB1304	DB1304	DB1333		DB1338
Roller fairlead	DB1307	DB1307	DB1307	DB1307	DB1341
Remote control	DB1326 - 15mm socket DB1327 - 20mm socket	DB1326 - 15mm socket DB1327 - 20mm socket	DB1327	DB1326 - 15mm socket DB1327 - 20mm socket	DB1334
Winch cable	DB1328	DB1328	DB1328	DB1328	DB1339
Brush and holder set	DB1330	DB1330	DB1331	DB1331	DB1340

Note - Early models of DB1200i & DB9500i were fitted with an external thermal cut-off switch. Replacements are still available - **DB1305**



Britpart DB2000 fitted to a working model of a Land Rover

WINCHING ACCESSORIES



DB1003



DB1004



DB1005



DB1315

Fairleads

DB1003	Hawse fairlead - mounting holes 255mm, large aperture
DB1004	Hawse fairlead - mounting holes 255mm, medium aperture
DB1005	Hawse fairlead - mounting holes 125mm
DB1315	Hawse fairlead - aluminium
DB1316	Roller fairlead - stainless steel
DB1317	Hawse fairlead - stainless steel



DB1316



DB1317

More winching accessories over the page...



DB1006



DB1011



STC8919AA



DA3028



DA3030



DA3034



DB1007

Ropes & Straps

DA2246	Tow strap	2t WLL	5m x 60mm
DB1006	Tow strap - 60mm x 9 metre with a breaking strength of 8,000kgs and reinforced eyes		
DB1011	High elasticity tow sling - 9 metre with a 10 ton pulling capacity. Complete with reinforced eyes and overload warning tag.		
STC8919AA	Tow strap	Discovery 3/Range Rover L322/Range Rover Sport	
DA3028	Rope - polypropylene	2t WLL/8t MBL	5m x 24mm
DA3029	Rope - nylon	2t WLL/12t MBL	5m x 24mm
DA3030	Kinetic recovery rope - octoplait	2t WLL/12t MBL	5m x 24mm
DA3031	Kinetic recovery rope - octoplait	2t WLL/12t MBL	8m x 24mm
DA3032	Tree strap	2t WLL/14t MBL	3m x 90mm
DA3033	Tree strap	2t WLL/14t MBL	4m x 90mm
DA3034	Tree strap	2t WLL/14t MBL	6m x 90mm
DB1007	Tree protection belt - 1.6 metre 4 ton		

Note - WLL = working load limit (lifting), MBL = minimum breaking load



WINCHING ACCESSORIES - continued



DA3160



DB1002



DB1008



DB1009



DB1012



DB1322



DB1323



DB1329

Shackles & Pulleys

- DA3160** Swivel recovery eye - stainless steel **Note** - not suitable for standard Land Rover bumpers
- DB1002** Snatch block - high quality tempered steel suitable for winch ropes from 5mm to 10mm
Maximum head load - 16,000lbs
- DB1008** Pulley hook - SWL loads 1,500kgs for pulling, 750kgs for lifting
- DB1009** Shackle - 1.4 ton
- DB1012** Shackle - 4.7 ton
- DB1322** Swivel shackle
- DB1323** Non-forged jate ring
- DB1329** Forged jate ring



DA2037

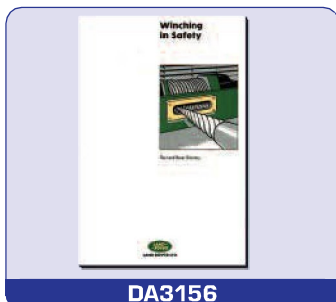

DA3156



DB1000



DB1010



DB1016



DB1308

Safety Equipment

- DA2037** Battery isolator switch universal
- DA3156** Winch in safety book
- DB1000** Wheel chocks - pair
- DB1010** Gloves - for protection winch operation
- DB1016** Winch blanket - manufactured from heavy-duty vinyl, the blanket will absorb most of the recoil in the unlikely event of the cable breaking. It's also very useful to kneel on in the mud!
- DB1308** Winch remote control - operate your winch from a safe distance with this wireless remote control
- NEW**
 - > High frequency circuit using SMD design for reliability
 - > The transmitter uses FM technology for frequency stability and greater control distance
 - > Receiver output is protected against voltage spikes

WINCHING ACCESSORIES - continued



DB1001



DB1014



DB1309

Other Essential Winching Accessories

- DB1001** Winch bag - a heavy-duty black and green bag
- DB1013** 12 Strand plasma winch line - 9.5mm (3/8"), 17,500lbs NBS x 100ft (30.5m). Supplied fully finished with a galvanised tube thimble, large safety hook and 2m of heavy-duty black rock guard.
- DB1014** Extended winch wiring kit - 1 x red, 1 x black wire, each 1.8m in length with end connectors and cut-off switch for Defender vehicles
- DB1309** 'Dyneema Bowrope' - 12 strand synthetic fibre replacement winch rope - 11mm x 90ft
NEW
 - > For use with DB9000C, DB9500i and DB12000i winches
 - > CE certified
 - > Easy to handle
 - > Floats
 - > Does not kink
 - > Very light
 - > Easily spliced
 - > Highly visible
 - > Less effort in use
 - > Very strong
 - > Does not curl
 - > Compact
 - > Safety in use
- DB1314** Ground anchor set
- DB1318** Ground anchor bag set - 2 x Pulling Power bags, ground anchor not included (DA1314)
- DB1328** Replacement winch cable with hook - 30.5m x 9.5mm



DB1318



DB1314



DB1013



DB1328

WINCHING ACCESSORY KITS



DB1017



DB1015

- DB1017** Contents -
 - 1 x DB1001 Winch kit bag
 - 1 x DB1002 Snatch block - 16,000lbs
 - 1 x DB1006 Tow strap - 8 ton, 60mm x 9m
 - 1 x DB1007 Tree strop
 - 1 x DB1010 Winching gloves
 - 2 x DB1012 Alloy bow shackle - 4.75 ton
- DB1015** Contents - as per DB1017 plus
 - 1 x DB1000 Wheel chocks (pair)
 - 1 x DB1011 Snatch tow sling - 10 ton
 - 1 x DB1016 Winching blanket

Britpart Pulling Power winching recovery kits come with all the basic items needed to ensure your winch can be used to the best effect. There is a choice of a starter or professional kit depending on your needs.





Ooops!

“Glad I’ve got that
Britpart winch”

11

performance equipment

PERFORMANCE EQUIPMENT

Upgrade your Land Rover from its standard spec into something a bit more special.

Section contents -

Air filters - Britpart Performance	94
Air filters - K&N Consumables	95
Brake discs - Britpart Performance	96
Brake hose kits	95
Brake lubrication	95
EBC brake parts	97 - 98
EGR blanking kits	99
Handbrake conversion kits	99
Intercooler silicone hoses	100
Intercoolers - performance	100
PSI power tuning products	101
Weber carburettors	101



AIR FILTERS - BRITPART PERFORMANCE

DA3138 Series 3 - 4-cylinder - fits Zenith and Weber carbs



DA3139 Corresponds to PHE000112

Discovery 3 - 2.7 V6 diesel, 4.0 V6 petrol & 4.4 V8 petrol
Range Rover Sport - 2.7 V6 diesel, 4.0 V6 petrol & 4.4 V8 petrol



DA4259 Corresponds to PHE000040

Range Rover L322 - Td6



DA4260 Defender 90/110/130 - 2.5 Td5 1999 - 2007

Discovery 2 - Td5 1999 - 2004
Discovery 2 - 4.0i 1999 - 2004
Freelander 1 - V6 petrol
Range Rover P38 - 2.5DSE diesel (BMW engine) 1998 - 2002
Range Rover P38 - 4.0i V8 1994 - 2002
Range Rover P38 - 4.6i V8 1994 - 2002

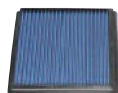

DA4261 Corresponds to ESR1445

Discovery 1 - 2.0i Mpi petrol
Discovery 1 - 2.5 300Tdi 1994 - 1997
Discovery 1 - 3.9i V8 1994 - 1997
Range Rover Classic - 2.5 300Tdi 1992 - 1994
Range Rover Classic - 3.9i V8 Efi 1994



DA4262 Corresponds to NTC1435 & ESR2623

Defender 90/110/130 2.5 300Tdi 1994 - 1997
Discovery 1 - 2.5 200Tdi 1989 - 1992
Range Rover Classic - 2.4D VM Turbo 1986 - 1992
Range Rover Classic - 2.5D VM Turbo 1986 - 1992



DA4263 Corresponds to PHE100500L

Freelander 1 - 2.0 Td4 (BMW engine) 2001 - 2006



DA4264 Corresponds to ESR1049

Discovery 1 - 2.5 200Tdi 1992 - 1994
Range Rover Classic - 2.5 200Tdi - 1992 - 1994



DA4265 Corresponds to ESR341

Range Rover Classic - 4.0i V8 1990 - 1995
Range Rover Classic - 4.2i V8 1990 - 1995
Range Rover Classic - 4.6i V8 1990 - 1995
Range Rover P38 - 2.5DSE diesel (BMW engine) 1994 - 1997



DA4266 Range Rover Classic - 3.5 carb V8

Cone type - replaces 605191 - 2 filters required



DA4267 Corresponds to ESR4103

Freelander 1 - 1.8 16v 1997 - 2000
Freelander 1 - 2.0i Tc1e diesel (Rover engine) 1997 - 2000



DA4268 Corresponds to RTC4683

Discovery 1 - 3.5i V8 Efi 1990 - 1993
Range Rover Classic - 3.5i V8 Efi 1985 - 1989
Range Rover Classic - 3.9i 1989 - 1994



DA4269 Corresponds to NRC9238

Defender 90/110/130 - 2.5 petrol 1983 - 1990
Defender 90/110/130 - 2.5 D & Td 1983 - 1990



DA4270 Corresponds to NTC6660

Defender 90/110/130 - 2.5 200Tdi 1990 - 1993



DA4271 Corresponds to ESR4238

Defender 90/110/130 - 2.5 Td5 1999 - 2007
Discovery 2 - Td5 1999 - 2004
Discovery 2 - 4.0i 1999 - 2004



DA4272 Range Rover Classic - 3.5 carb V8

Cone type off-road extreme power filter - 2 filters required



DA4274 Corresponds to 605191

Series 3 - 109 3.5 V8 1979 - 1982 - 2 filters required
Discovery 1 - 3.5 V8 carb 1989 - 1990 - 2 filters required
Range Rover Classic - 3.5 V8 carb 1972 - 1986 - 2 filters required



A breath of
fresh air
for your
Land Rover

- > A range of performance filters tailored to fit your Land Rover
- > Maximum breathing efficiency for your engine means more power or better fuel mileage



- > No compromise on quality - the engine gets more air but the dirt particles are trapped by the quality filters
- > No need to replace as easy cleaning means maximum performance guaranteed
- > Easy fit, directly replaces standard air filter
- > Ideal for use in hot dusty conditions to reduce engine wear
- > Compatible with snorkels, ideal for use in conjunction with other performance modifications
- > Filters don't need pre-oiling and if the filter gets dirty there is no need to use a cleaner to clear the dirt on the filter - just use air, water or detergent



"breathing efficiency for your engine means more power or better fuel mileage"

AIR FILTERS - K&N CONSUMABLES



DA4275 DA4276 DA3136 DA3137

K&N Dirt Retention Lubricating Oil

DA4275 K&N Oil - 200ml aerosol
DA4276 K&N Oil - 250ml bottle

K&N Cleaning Solution

DA3136 1ltr Bottle
DA3137 Cleaning kit - 200ml cleaning fluid & 200ml lubricating oil

BRAKE LUBRICATION **NEW**

Cera-Tec Advanced Lubricant

Mintex Cera TEC is an advanced non-metallic universal lubricant that provides many benefits over traditional copper-based grease.

DA2389

- > Non-metallic content - ABS and ESP friendly
- > Operates to a high temperature (1,000°C)
- > Non-conductive
- > Free of copper and acid
- > More effective at reducing any brake squeal
- > Protects against corrosion and dirt
- > Neutral colour prevents any visible residue or staining



DA2389

BRAKE HOSE KITS

	Standard		Plus 40mm	
	Goodridge	Britpart Stainless Steel	Goodridge	Britpart Stainless Steel
Defender 90				
1984 to 1998 WA159806		DA2400S		DA240040S
1999 to 2004 from XA159807 metric non abs		DA2401S		DA240140S
Defender 110				
1983 to 1998 WA159806		DA2402S		DA240240S
Discovery 1				
1989 to 1992 to JAO34313	DA2410	DA2410S		DA241040S
1992 to 1995 KAO34314 to LA081991	DA2411	DA2411S	DA241140	DA241140S
1995 to 1999 from MA018992 non-abs	DA2412	DA2412S		DA241240S
1995 to 1999 from MA018992 abs	DA2413	DA2413S	DA241340	DA241340S
Discovery 2				
ABS		DA2414S		DA241440S
Range Rover Classic				
Up to 1981 UNF non-abs			DA240340	DA240340S
1981 to 1990 metric non-abs				DA240440S
107 up to 1981 UNF non-abs			DA240540	
1990 to 1992 abs				DA240640S
1992 abs				DA240740S
1992 to 1995 non-abs			DA240840	
Range Rover P38				
1995 to 2001		DA2409S		
Series 2 & 3				
88 imperial 1960 to 1979	DA2418	DA2418S	DA241840	DA241840S
88 metric 1980 to 1984	DA2419	DA2419S	DA241940	DA241940S
109 imperial 1971 to 1979 approx	DA2420	DA2420S	DA242040	DA242040S
109 metric 1980 to 1984	DA2421	DA2421S	DA242140	DA242140S



BRITPART

The quality parts for Land Rovers

Increase your braking efficiency

These brakelines are constructed from the finest quality hose, consisting of a PTFE inner and stainless steel overbraid and both the Britpart and Goodridge brands offer -

- > Eliminates sponginess under heavy braking
- > Increases braking efficiency
- > Abrasion and corrosion resistant



GOODRIDGE



BRITPART PERFORMANCE BRAKE DISCS

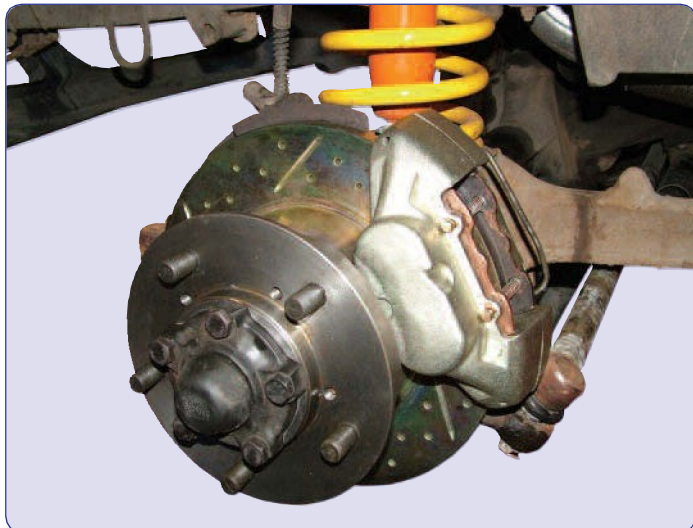

- > Slotted design to increase braking efficiency by reducing dust, debris, water and gas on the disc.
- > To improve brake cooling, reduce weight and to offer an escape route for dirt and gasses these performance discs are drilled with rows of holes.
- > Excellent upgrade for your Land Rover to aid braking, especially under a heavy load.
- > Ideal for off-road use.
- > Manufactured to British Standard BS1452 Grade 220 and DIN1691 GG20.
- > Supplied in pairs.



DA4600

Quality manufactured slotted brake discs! BRITPART

DA4600	FRC7329	Front	Defender 1987-2006, 2007->/Discovery 1/Range Rover Classic 1986-1991
DA4601	FTC1381	Rear	Defender 1987-2006, 2007->/Discovery 1/Range Rover Classic 1986-1994
DA4602	FTC902	Front	Defender 1987-2006, 2007->/Discovery 1/Range Rover Classic 1986-1994
DA4603	NTC8780	Front	Range Rover P38 1995-2002
DA4604	SDB000470	Rear	Range Rover P38 1995-2002/Discovery 2
DA4605	SDB000330	Rear	Defender 1987-2006, 2007->
DA4606	SDB000380	Front	Discovery 2
DA4607	SDB100830	Front	Freelander 1 1996-> - up to YA999999
DA4608	SDB101070	Front	Freelander 1 1996-> - from 1A000001
DA4609 NEW	SDB000201	Front	Range Rover L322
DA4610 NEW	SDB000211	Rear	Range Rover L322

IMPORTANT BRAKE INFORMATION

For exact change over points with vehicle applications please contact your local Britpart distributor with the full chassis number for the correct application. These references are intended as a guide only.



Picture courtesy of Jake Perks

EBC BRAKE DISCS

EBC BRAKES

- > Wide aperture slots that draw cool air under the pad surface.
- > Slots that expel all dirt dust and debris from the braking area.
- > Blind drilled dimples that eliminate cracking common with through drilled sport rotors whilst helping maintain perfect pad contact.
- > Gold zinc corrosion resistant coating.



EBC Brake Discs - Pairs

DA4147	NTC8780	Front	Vented	Range Rover P38 1995-2002
DA4148	NTC8781 & SDB000470	Rear	Solid	Range Rover P38 1995-2002/Discovery 2
DA4151	FTC902	Front	Vented	Defender 1987-2006, 2007->/Discovery 1/Range Rover Classic 1986-1994
DA4152	FTC1381 & 571912	Rear	Solid	Defender 1987-2006, 2007->/Discovery 1/Range Rover Classic
DA4158	ANR4582 & SDB000380	Front	Vented	Discovery 2
DA4165	FRC7329	Front	Solid	Defender 1987-2006, 2007->/Discovery 1/Range Rover Classic
DA4166	571762	Front	Solid	Range Rover Classic to 1985
DA4475	SDB000604	Front	Vented	Discovery 3/Range Rover Sport - various applications
DA4473	SDB000636	Rear	Vented	Discovery 3/Range Rover Sport - various applications
DA4187	SDB000614	Front	Vented	Discovery 3/Range Rover Sport - various applications
DA4188	SDB000646	Rear	Vented	Discovery 3/Range Rover Sport - various applications
DA4472	SDB000211	Rear	Solid	Range Rover L322 - various applications
DA4474	SDB000201	Front	Vented	Range Rover L322 - various applications
DA4476	SDB500193	Front	Vented	Range Rover L322 - various applications
DA4477	SDB101070	Front	Vented	Freelander 1 1996-> - from 1A000001

IMPORTANT BRAKE INFORMATION

For exact change over points with vehicle applications please contact your local Britpart distributor with the full chassis number for the correct application. These references are intended as a guide only.

EBC BRAKE PADS

- > New AF42/66 friction material which completely eliminates brake judder and produces a high friction long lasting brake pad.
- > Unique powder coat finish to both pad and back plate gives lifetime resistance to corrosion and prevents moisture ingress.
- > Unique Brake-In surface coating provides instant brake efficiency on installation and conditions the brake rotor removing glaze, black spotting etc from disc surface.
- > All pads feature centre line slot which prevents heat expansion cracks and reduces brake noise.
- > All pads feature edge chamfers which have major technical benefits;
 - Significant reduction in brake noise
 - Prevents 'edge lifting' under left and right extremities of pad which can cause corrosion ingress and eventual pad de-bond
 - Can extend pad life by virtue of improved pad efficiency
- > Most pads in the Ultimax range features factory fitted noise reduction shims.

* pad sets excludes shims

Ultimax

EBC BRAKES



EBC Ultimax Heavy-duty Brake Pads - Sets

DA3300	SFP100460	Front	Range Rover P38 1995-2002/Discovery 2
DA3301	SFP500100	Front	Freelander 1 1996-> - from 1A000001
DA3302	SFP100360	Front	Freelander 1 1996-> - up to YA999999
DA3303	SFC500050	Front	Range Rover L322 - various applications
DA3304	SFP500010	Front	Range Rover L322/Range Rover Sport/Discovery 3 - various applications
DA3306	LR004936	Front	Freelander 2
DA3307	STC9186	Front	Range Rover Classic to 1986/Defender 90 to 1986
DA3308*	STC2950	Front	Defender 110 to 1986
DA3309*	STC9187	Front	Range Rover Classic 1986 to 1991/Discovery 1 to 1993
DA3310*	STC2952	Front	Defender 110 from 1986/Defender 90 from 1991
DA3311*	STC9191	Front	Defender 90 1986 to 1991/Discovery 1 from 1994
DA3312*	STC9190	Front	Discovery 1/Range Rover Classic 1986 to 1996 with sensor
DA3313*	STC1601	Rear	Defender 110 from 1994
DA3314	SFP100470	Rear	Range Rover P38 1995-2002/Discovery 2
DA3315	SFP000120	Rear	Range Rover L322 - various applications
DA3316	SFP500140	Rear	Range Rover L322/Range Rover Sport/Discovery 3 - various applications
DA3318	SFP000270	Rear	Range Rover Classic to 1985/Discovery 1 without sensor/Defender 90 from 1994
DA3319*	STC9189	Rear	Range Rover Classic from 1986/Discovery 1 with sensor

EBC BRAKE PADS - continued



> Unique "Brake-In" surface coating to accelerate pad bed in
 > 100% British design and manufacture

- > 100% British design and manufacture.
- > Superb gloss powder coat paint finish to reduce corrosion.
- > Unique engineering finish with noise reduction slots and edge chamfers.
- > Extra high friction compounds for better stops, these pads will improve your stopping power by up to three vehicle lengths.
- > Special compound ingredients that prevent "Outline Etching" eliminating brake stiction onto the rotor in damp conditions.
- > Unique "Brake-In" surface coating to accelerate pad bed in after installing new pads which also guarantees brake efficiency from install.
- > Super quiet braking with rubber-steel-rubber noise reduction shims on the reverse, this dampens all possible noise.
- > Extra heavy duty compound lasts longer than low cost standard pads
- > Fully ECE R 90 approved and legal for road and off road use.



EBC Green Stuff High Performance Brake Pads - Sets

DA4149	SFP100460 & SFP100480	Front	Range Rover P38 1995-2002/Discovery 2
DA4150	SFP100470 & SFP500130	Rear	Range Rover P38 1995-2002/Discovery 2
DA4153	STC9186 & STC9187	Front	Range Rover Classic to 1986/Defender 90 to 1986
DA4154	STC9189	Rear	Range Rover Classic to 1985/Discovery 1 with sensor/Defender 90 from 1994
DA4155	SFP500200	Rear	Range Rover Classic from 1986/Discovery 1 with sensor
DA4156	STC9190	Front	Discovery 1/Range Rover Classic 1986 to 1996 with sensor
DA4157	STC9191	Front	Defender 90 1986 to 1991/Discovery 1 from 1994
DA4159	STC2952 & SFP000260	Front	Defender 110 from 1986/Defender 90 from 1991
DA4185	STC1601 & SFP000280	Rear	Defender 110 from 1994
DA4478	SFP500100	Front	Freelander 1 1996-> - from 1A000001
DA4479	SFP100360	Front	Freelander 1 1996-> - up to YA999999
DA4480	SFC500050	Front	Range Rover L322 - various applications
DA4481	SFP500010	Front	Range Rover L322/Range Rover Sport/Discovery 3 - various applications
DA4482	SFP500070	Front	Range Rover L322/Range Rover Sport - various applications
DA4483	SFP000120	Rear	Range Rover L322 - various applications
DA4484	SFP500140	Rear	Range Rover L322/Range Rover Sport/Discovery 3 - various applications
DA4485	SFP000270	Rear	Range Rover Classic to 1985/Discovery 1 without sensor/Defender 90 from 1994

IMPORTANT BRAKE INFORMATION

For exact change over points with vehicle applications please contact your local Britpart distributor with the full chassis number for the correct application. These references are intended as a guide only.



> Effective brake upgrade for heavy duty braking
 > High friction compound

EBC Yellowstuff brake pads are British made with Aramid fibres such as Kevlar and Twaron and are one of the highest friction brake pad compounds on today's market. Not only high in friction from first application when brakes are cold but extremely effective at higher brake temperatures as encountered in faster driving and towing/trailing. These pads are a favourite with the military and are used on armoured vehicles in several countries to handle the higher loads and heat and offer a good brake upgrade. Fitted with shims chamfers, centre slots and the unique EBC Brake in coating for fast bedding in of new brakes these pads are also long lasting and silent in operation.

- > High friction compound
- > Effective from cold up to high heat
- > Effective brake upgrade for heavy duty braking
- > Long lasting powerful brakes
- > Shims, edge chamfers and slots for silent braking



EBC Yellow Stuff Performance Race Brake Pads - Sets

DA4335	SFP500010	Front	Range Rover L322/Range Rover Sport/Discovery 3 - various applications
DA4336	SFP500150	Front	Range Rover P38 1995-2002/Discovery 2
DA4337	SFP500070	Front	Range Rover L322/Range Rover Sport - various applications
DA4338	SFC500050 & SFC500080	Front	Range Rover L322 - various applications
DA4339	SFP500130	Rear	Range Rover P38 1995-2002/Discovery 2
DA4340	SFP500140	Rear	Range Rover L322/Range Rover Sport/Discovery 3 - various applications
DA4341	SFP500210	Rear	Range Rover L322 - various applications

EGR BLANKING KITS **NEW**

A Britpart EGR (exhaust gas recirculation) blanking kit enables you to remove the original mechanical EGR from the vehicle resulting in better fuel economy and improved performance.

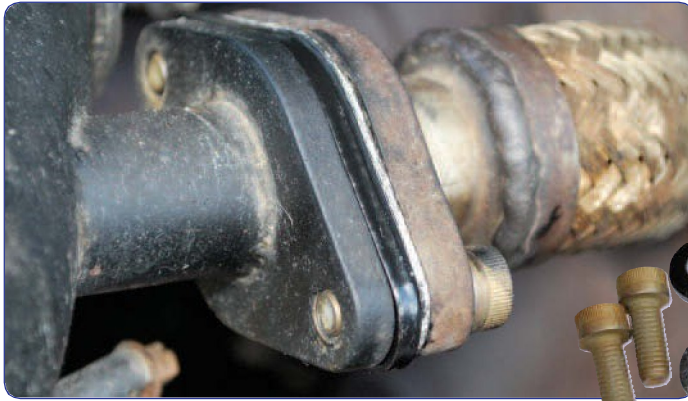

DA1108



DA1109



DA1112

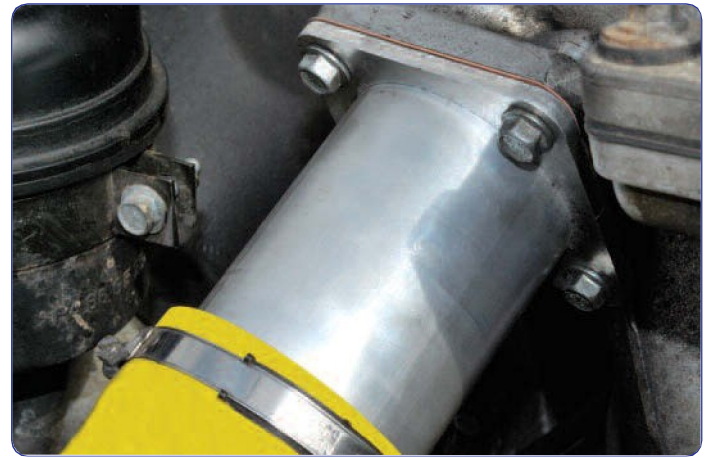

- DA1108** 300Tdi EGR blanking kit
- DA1109** Td5 EGR blanking kit
- DA1112** TdV6 up to 7A (not EU4)



Picture courtesy of Paul Wade

HANDBRAKE CONVERSION KITS

Beef up your handbrake!



DA5526

- DA5513** Defender 1987 - 2006
- DA5526** Discovery 1/Discovery 2 & Range Rover Classic

Note - will not fit Range Rover Classics with a Borg Warner or LT95 transfer box.

The standard Land Rover hand brake can easily get bunged up with dirt if you drive off-road a lot and once the mechanism gets clogged up it doesn't work as efficiently as it should. Britpart now offer a solution to that problem - a drum to disc conversion kit.

This kit uses a powerful caliper whose mechanism is sealed to prevent the access of mud! The special pads provide greater friction than the standard ones and are resistant from abrasion from mud.



DA5513

INTERCOOLERS - PERFORMANCE

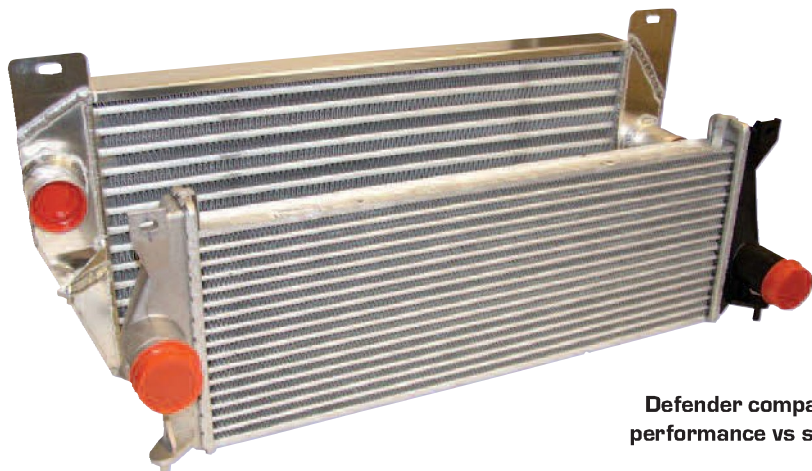

Defender comparison - performance vs standard

These high performance and robust units are constructed from polished aluminium and are 30% larger than the standard intercooler. As a result air has a chance to cool before entering the engine. This cooler air can increase engine power by up to 25bhp [subject to application]. Other benefits include better throttle response and reduction in fuel consumption depending on driving conditions. Ideal for on or off road use. Fully pressure tested, capped and sealed. Manufactured in the UK.

DA4630	Defender 90/110 Td5 - 1998-2006 Inc. air-con vehicles	60mm deep x 300mm high
DA4631	Discovery 2 Td5 - Automatic - 1999-2004	60mm deep x 235mm high
DA4632	Discovery 2 Td5 - Manual - 1999-2004	60mm deep x 300mm high
DA4633	Range Rover P38 DSE	60mm deep x 280mm high

Notes - Dimensions for main intercooler body only. If you have a winch fitted please check clearance before fitment.



DA4630



DA4631

increase engine power & reduce fuel consumption



DA4633



DA4632

INTERCOOLER SILICONE HOSES NEW

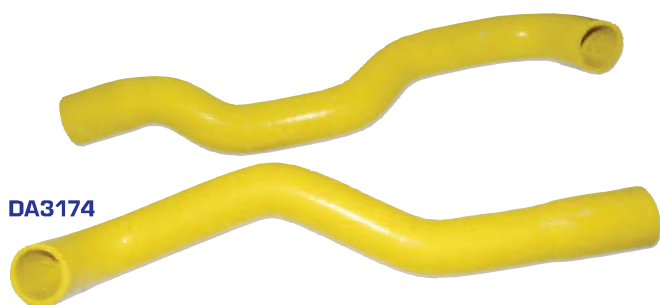

DA3174



DA3176

Britpart Yellow Silicone Hose Kits

Quality silicone intercooler hoses designed to operate at a higher temperature than the original hoses. Fits with both standard and performance intercoolers.

DA3170	Defender - 200Tdi	4 piece kit
DA3171	Defender - 300Tdi	3 piece kit
DA3173	Defender - Td5	3 piece kit
DA3174	Defender - 2007 onwards	2 piece kit
DA3175	Discovery 1 - 200Tdi	3 piece kit
DA3176	Discovery 1 - 300Tdi	3 piece kit
Note - remove EGR valve and pipe		
DA3177	Discovery 2 - Td5	3 piece kit
DA3182	Freelander 1 - Td4	2 piece kit



DA3170



DA3173

PSI POWER TUNING PRODUCTS

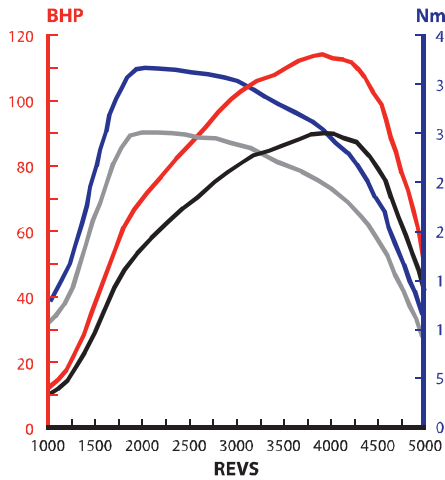

Performances for Defender Td5:
 Standard: 122 HP 90 kW 300 Nm
PSI: 155 HP 114 kW 365 Nm

The Power Box houses a digital microprocessor which intercepts the fuelling signals being transmitted from the ECU to the fuel pump; it then modifies them to ensure the exact amount of diesel required for enhanced performance. Such efficient use of the fuel optimises consumption, reduces smoke emissions and there is less engine stress, enhancing engine life in many cases.

The Power Box improves torque enabling the vehicle to change gears earlier and hold higher gears at lower speeds, making driving more pleasurable.

The unit fits using the original manufacturers plugs; these existing plugs are opened and the Power Box is secured in between. Full fitting instructions are included with every unit.



Features

- > Plug-in unit
- > No intervention with the original ECU
- > 1-year equipment warranty & 1-year engine warranty - subject to terms *
- > TUV approval
- > Compact size
- > Shock resistant & waterproof
- > Competitively priced

* vehicles up to 40,000km and up to 3 years old

Benefits

- > Can be removed prior to sale or used as a selling point
- > Traceless
- > Peace of mind
- > Quality product which is legal & safe
- > Unobtrusive in interior of vehicle
- > No worries off road
- > A good investment

Performance improvement - (before/after)

	Power - HP	Power - Kw	Torque - Nm
DA4418	112/ 129	82/ 95	260/ 300
DA4419	136/ 160	100/ 118	268/ 310
DA4420	136/ 160	100/ 118	268/ 310
DA4421	177/ 203	130/ 149	390/ 440
DA4433	122/ 155	90/ 114	300/ 365
DA4436	122/ 150	90/ 110	360/ 415

DA4418

Freelander - Td4 2000 - 2006

DA4419

Range Rover - 2.5Td 1995 - 1999

DA4420

Range Rover - 2.5Td 2000 - 2001

DA4421

Range Rover - Td6 2002 onwards

DA4433

Defender & Discovery - Td5 1995 - 2007

DA4436

Defender 2007 onwards

Improves torque

Improves m.p.g

WEBER CARBURETTORS

DA3049

V8 4-Barrel conversion kit including manifold

The Webcon 4 barrel replacement carburettor kit is a direct replacement for the twin Stromberg or SU carbs fitted to the Rover V8. Calibrated to work perfectly on the 3.5 and 3.9 engines, the Webcon kit is the most complete on the market and features a Webcon modified Weber 4 barrel 500cfm carburettor, intake manifold, air filter and every single nut, bolt washer, gasket and hose that could possibly be needed. The kit adds up to 20bhp at the wheels and transforms the driveability and economy. Starting becomes instant either hot or cold and with no balance adjustment to worry about with twin carbs, the engine is simply superbly smooth as indeed a V8 should be.

DA3049AF

Replacement air filter for DA3049

DA2126

Series

To replace Solex use also STC541 adaptor

DA2206

Service kit for DA2126

DA2126A

Choke cable for DA2126

ERC2886W

Series

Replacements for the Zenith 36IV

Available for LHD, RHD, with or without fuel shut off solenoid, the Weber range of carburettor kits to replace the Zenith 36IV offer the optimum balance of power and economy together with the legendary quality and reliability of Weber. Shipped as complete turnkey solutions, all kits are supplied with every nut, bolt, washer and gasket required and comprehensive, easy to follow instructions ensure that installation can be carried out with no specialist carburettor knowledge.

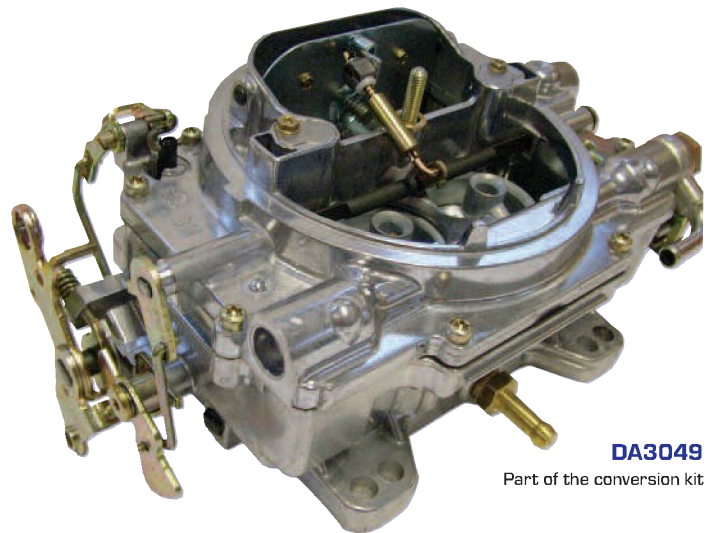

DA3049

Part of the conversion kit



DA2126



ERC2886W



Picture courtesy of Paul Wade

12

suspension equipment
SUSPENSION EQUIPMENT

Firm up your ride with some new shockers and springs or raise your game with a lifted suspension kit.

Section contents -

Air lift kits	104
Air spring conversion kits	104
Air springs - Britpart	105
Anti-roll bar kit	105
Britpart Cellular Dynamic shock absorbers	108
Britpart Super Gaz shock absorbers	109
Bump stops	105
Bush fitting tool	105
Bush sets - Britpart other	105
Bush sets - Britpart polyurethane	106
Dislocation cones	107
Panhard rod	107
Polybush sets	107
Radius arms	107
Shock absorber brackets	110
Shock absorbers - Delphi De Carbon	110
Shock absorbers - heavy-duty	111
Spring retainers	112
Springs - coil	111
Springs - parabolic	112
Steering arms - heavy-duty	112
Suspension kits - Britpart	113
Suspension matrix	114
Wide angle propshafts	113



AIR LIFT KITS NEW



Adjustable Air Helper Springs

The load and towing problem solver

Air adjustability is the difference! Stiff steel factory suspensions must compromise between ride comfort and load hauling capacity. Smooth ride suspensions can't carry heavy loads; heavy springs ride rough, especially when the vehicle is unloaded. Air Lift adjustable air springs solve these problems by allowing you to tune your suspension under all load and road conditions. Just add air when towing or hauling and then remove air for a softer ride when unloaded.

Features and benefits of Air Lift 1000

- > Improve ride, handling and stability by reducing roll, sway and "bottoming out"
- > Fits open coil springs, front or rear
- > Up to 1,000lbs of levelling capacity
- > Tough long-lasting moulded polyurethane construction
- > Quick connecting easy-to-use engineered polymer air fittings

Air Lift 1000

- DA5010** Defender 110 & 130
- DA5011** Defender 90 / Discovery 1 & Range Rover Classic



DA5010 / DA5011

DA5012 Load Controller II

The economical, popular, basic on board air system. This system controls the rear bags equally. All kits include wiring harness for fast, easy installation. To eliminate the major cause of air spring failure, the low pressure sensor automatically activates if pressure falls below the minimum safe level.



DA5012

AIR SPRING CONVERSION KITS

Discovery

It is a sad fact that sometimes the air suspension at the rear of a Discovery 2 will fail. You then have a choice to make. Do you replace it with a replacement air spring system which is comfortable but not comfortable on the wallet or replace with an equally comfortable but much more affordable coil suspension system. Well Britpart have the complete kit for air to coil suspension conversion making your decision that bit easier:

- Kit - 2 x Rear springs; 2 x Isolators; 2 x Spring seats; 4 x Bolts;
- 1 x Instructions

DA5136 Discovery 2 - air to coil conversion kit



DA5136

Conversion to coil springs provides a better, maintenance-free ride

Range Rover

The EAS (Electronic Air Suspension) System found on Range Rover 4.0 and 4.6 vehicles can present expensive, recurring maintenance problems. If you've had an air spring failure before, you know this first hand. Britpart now has a coil spring conversion kit for Range Rover 4.0/4.6 that makes switching to coil springs seamless and error-free. Conversion to coil springs provides a better, maintenance-free ride that will save you significant money over time. The EAS Override Module suppresses all typical false dashboard display errors and buzzers seen when converting to coil springs. Any mechanic or Range Rover owner can install this coil spring conversion kit without having to go to a Land Rover dealer or Autologic-equipped repair shop to eliminate false dash warning light errors. The kit features:

- > Detailed step-by-step instructions.
- > The EAS Override Module overrides all typical computer errors seen when converting to a coil spring system.
- > Eliminates the need for a costly shop visit.
- > Aluminium spring perch adapters.
- > Britpart custom made coil springs provide standard ride height and maximum articulation.
- > Affordable alternative to expensive, recurring air suspension failures.
- > Trip computer compatibility - maintains operation of your vehicle's trip computer.
- > Kit provides everything needed to complete a professional installation.

- DA4136** Range Rover P38 1995 - 2002 Petrol models and diesel light duty
- DA4136HD** Range Rover P38 1995 - 2002 Heavy-duty 1" lift including diesel models
- DA4179** Range Rover Classic No module



DA4136HD

AIR SPRINGS - BRITPART

Air springs can be susceptible to air leaks due to the fact the rubber seals dry out. Why not firm up your suspension and replace them with these quality air springs from Britpart.

Note - All sold individually.

DA2371	Discovery 2	Rear
	- with self levelling	
DA2372	Range Rover P38	Front
DA2373	Range Rover P38	Rear
NTC9819	Range Rover Classic	Front
NTC9820	Range Rover Classic	Rear
RKB101200	Discovery 2	Rear
REB101740	Range Rover P38	Front
RKB101460	Range Rover P38	Rear



NTC9819 & NTC9820



RKB101200

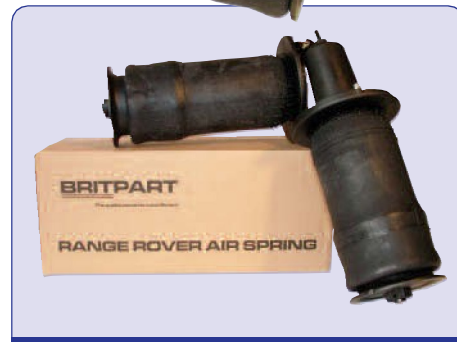

REB101740 / RKB101460

ANTI-ROLL BAR KIT

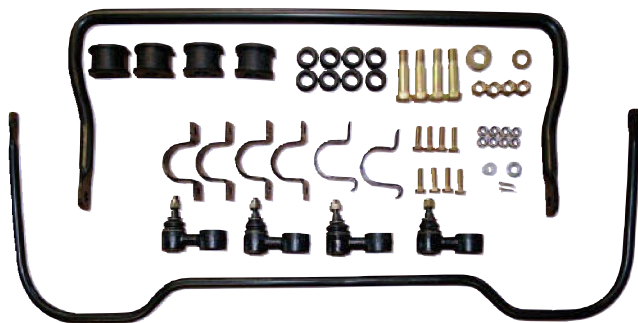

STC8156AA Defender 90/Discovery 1
Anti-roll bars for stiffening up your vehicle. Front and rear kit complete with fitting instructions.

BUMP STOPS **NEW**

Extended polyurethane bump stops should be used on vehicles with raised suspension to prevent the shock absorbers from bottoming out.

Normal - 56mm high
Extended - 80mm high

Note - All sold individually

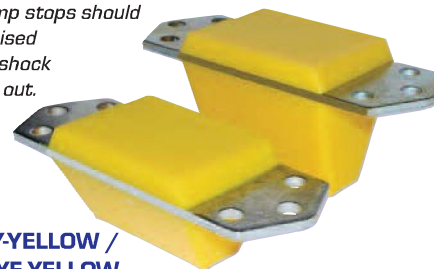

ANR4188PY / ANR4188PYE-YELLOW

ANR4188PY	Defender/Discovery 1	Front	Normal	Black
ANR4188PY-YELLOW	Defender/Discovery 1	Front	Normal	Yellow
ANR4188PYE	Defender/Discovery 1	Front	Extended	Black
ANR4188PYE-YELLOW	Defender/Discovery 1	Front	Extended	Yellow
ANR4189PY	Defender/Discovery 1	Rear	Normal	Black
ANR4189PY-YELLOW	Defender/Discovery 1	Rear	Normal	Yellow
ANR4189PYE	Defender/Discovery 1	Rear	Extended	Black
ANR4189PYE-YELLOW	Defender/Discovery 1	Rear	Extended	Yellow

BUSH SETS - BRITPART

Britpart - Blue

DA4035BLUE
Defender 90/110/130 to 1993
with drum brakes

DA4036BLUE
Range Rover Classic- 1986 onwards/
Discovery 1/Defender 1994 onwards

Britpart - Other

DA2353
Front radius arm to chassis kit
Defender 1987-1997/Discovery 1/
Range Rover Classic 1986-1994

DA4035YELLOW
Defender 90/110/130 to 1993
with drum brakes



DA4035BLUE



DA2353

LRT-60-004



Bush Fitting Tool - for ANR3332

Fitting new front radius arm bushes (part number ANR3332) for the Range Rover 38A is impossible to do without using the Land Rover special tool.

LRT-60-004
Land Rover special tool

BUSH SETS - BRITPART POLYURETHANE

Britpart - Individual bush sets

548205PY	Shackle bush
548205PY-YELLOW	Shackle bush set
552818PY	Shock absorber bush set
552818PY-YELLOW	Shock absorber bush set
552819PY	Shock absorber bush set
552819PY-YELLOW	Shock absorber bush set
568858PY	Washer - steering damper
568858PY-YELLOW	Washer - steering damper
569746PY	Chassis bush set
569746PY-YELLOW	Chassis bush set
572068PY	Radius arm/chassis outer bush set
572068PY-YELLOW	Radius arm/chassis outer bush set
572180PY	Mounting
572180PY-YELLOW	Mounting
575580PY	Panhard rod bush set
575580PY-YELLOW	Panhard rod bush set
90577434PY	Bush chassis
90577434PY-YELLOW	Bush chassis
ANR1721PY	Shock absorber bush set
ANR1721PY-YELLOW	Shock absorber bush set
ANR2563PY	Bush
ANR2563PY-YELLOW	Bush
ANR3285PY	Bush rear radius
ANR3285PY-YELLOW	Bush rear radius
ANR3305PY	Bush
ANR3305PY-YELLOW	Bush
ANR3332PY	Bush - radius arm
ANR3332PY-YELLOW	Bush - radius arm

ANR3410PY	Panhard rod bush set
ANR3410PY-YELLOW	Panhard rod bush set
ANR6947PY	Rear radius arm to axle bush
ANR6947PY-YELLOW	Rear radius arm to axle bush
ANR6947PY-YELLOW	Rear radius arm to axle bush
NRC4514PY	Bush set - radius arm to chassis
NRC4514PY-YELLOW	Bush set - radius arm to chassis
NRC5593PY	Bush set - shock absorber
NRC5593PY-YELLOW	Shock absorber bush set
NTC1772PY	Bush set - lower link/ axle
NTC1772PY-YELLOW	Bush set - lower link/ axle
NTC1773PY	Bush set - upper mounting
NTC1773PY-YELLOW	Upper mounting bush set
NTC1775PY	Bush - steering damper
NTC1775PY-YELLOW	Bush - steering damper
NTC6781PY	Bush set - radius arm/ axle
NTC6781PY-YELLOW	Bush set - radius arm/ axle
NTC6828PY	Bush
NTC6828PY-YELLOW	Bush
NTC7307PY	Bush set - radius arm/ axle
NTC7307PY-YELLOW	Bush set - radius arm/ axle
NTC7394PY	Bush
NTC7394PY-YELLOW	Bush
RBX101240PY	Bush - anti-roll bar

RBX101240PY-YELLOW	Bush - anti-roll bar
RBX101340PY	Bush kit - front panhard rod
RBX101340PY-YELLOW	Front panhard rod
RBX101680PY	Bush - front radius arm to axle
RBX101680PY-YELLOW	Front radius arm to axle
RBX101690PY	Bush - anti-roll bar front
RBX101690PY-YELLOW	Bush - anti-roll bar front
RBX101730PY	Bush - radius arm to chassis
RBX101730PY-YELLOW	Radius arm to chassis
RBX101780PY	Bush - lower arm
RBX101780PY-YELLOW	Bush - lower arm
RBX101790PY	Bush - lower arm
RBX101790PY-YELLOW	Bush - lower arm
RDB100080PY	Bush
RDB100080PY-YELLOW	Bush
RGX100970PY	Bush Assy polyurethane
RGX100970PY-YELLOW	Bush Assy polyurethane
RGX101000PY	Bush - trailing link
RGX101000PY-YELLOW	Bush - trailing link
RGX101010PY	Bush
RGX101010PY-YELLOW	Bush
RGX101020PY	Bush - outer
RGX101020PY-YELLOW	Bush - outer
RGX101440PY	Bush
RGX101440PY-YELLOW	Bush
RNF100090PY	Mounting - rubber
RNF100090PY-YELLOW	Mounting - rubber
STC618PY	Bush kit
STC618PY-YELLOW	Bush kit

Britpart -

Black suspension bush sets

DC7100	Discovery 1
DC7101	Discovery 2
DC7102	Freelander
DC7103	Series 1, 2 & 3 - excluding 3 LWB (see DC7104)
DC7104	Series 3 LWB
DC7105	Range Rover up to 1986
DC7106	Range Rover 1986 - 1994
DC7107	Range Rover P38
DC7108	Defender 1999 - 2007
DC7109	Defender up to 1993
DC7110	Defender 1994 - 1999
DC7111	Defender 2007 onwards
DA2426	Defender - steering damper bush set

Britpart -

Yellow suspension bush sets

DC7000	Discovery 1
DC7001	Discovery 2
DC7002	Freelander
DC7003	Series 1, 2 & 3 - excluding 3 LWB (see DC7004)
DC7004	Series 3 LWB
DC7005	Range Rover up to 1986
DC7006	Range Rover 1986 - 1994
DC7007	Range Rover P38
DC7008	Defender 1999 - 2007
DC7009	Defender up to 1993
DC7010	Defender 1994 - 1999
DC7011	Defender 2007 onwards
DA2425	Defender - steering damper bush set

Note - Part numbers without yellow as a suffix indicate the bush colour is black.



DC7008

- > Britpart are proud to present an exclusive range of Yellow and Black polyurethane bushes.
- > Manufactured exclusively for Britpart using the latest Vulkollan™ polyurethane technology.
- > Machined to exact tolerances once cast to produce the highest finish available.
- > Produced in both yellow and black they are both the same compound which gives similar ride characteristics to the standard rubber bushes, but they offer improved articulation, vibration damping and last longer.
- > The black bushes are ideal for replacing individual bushes as they can be fitted without a press.
- > The DC range of kits include shock absorber and A-frame bushes.

Manufactured exclusively for Britpart using the latest Vulkollan™ polyurethane technology

also available in black



DISLOCATION CONES

DA1962 NEW	Defender 110 Rear	Pair
DA2186	Defender 90/Discovery 1 Rear	Pair

These clever products ensures your springs relocate correctly when using your Land Rover in extreme conditions. Manufactured from stainless steel. Use in conjunction with spring retainers.



DA1962



DA2186

PANHARD ROD NEW

DA1130
Adjustable panhard rod for Defender Td5 and 2007 onwards

If your Defender has raised suspension it is wise to use an adjustable panhard rod to correct the axle position which will in turn maintain and restore the steering geometry.

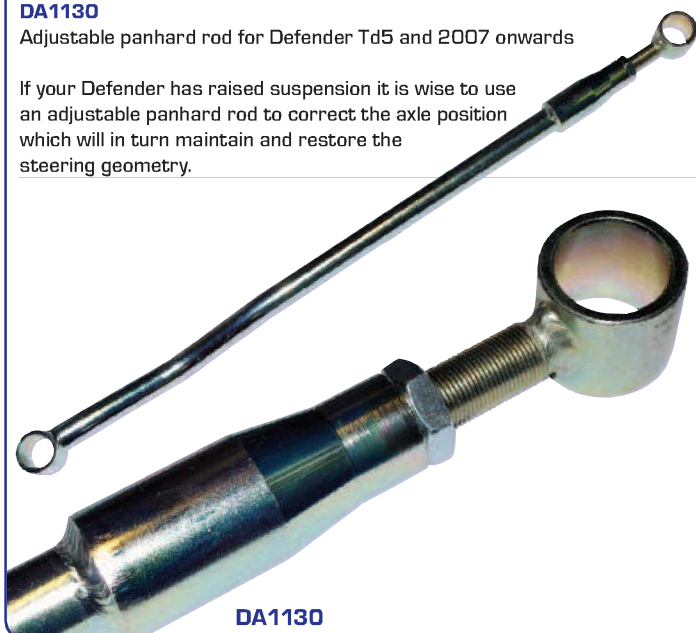

DA1130

POLYBUSH SETS

Polybush sets available from Britpart - full details supplied on request.



DA3144 NEW
Polybush Classic
Full kit for Discovery 3
Kit includes -

- > Front lower wishbone - front bushes
- > Front lower wishbone - rear bushes
- > Front upper wishbone bushes
- > Rear lower wishbone - front bush
- > Rear lower wishbone - rear bush
- > Rear upper wishbone - front bush
- > Rear upper wishbone - rear bush



RADIUS ARMS

Designed for vehicles with an extended 1 to 3" lift



DA5505 / DA5506

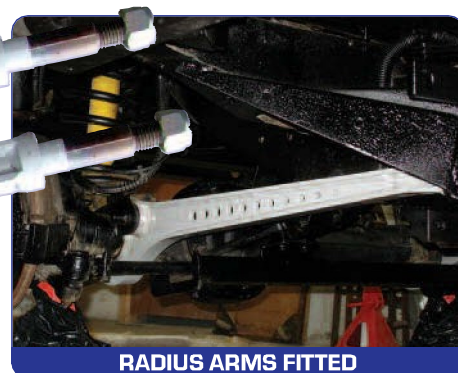

RADIUS ARMS FITTED

- > Designed for vehicles with an extended 1 to 3" lift.
- > Front radius arms correct castor alignment which in turn ensure safe driving.
- > Rear radius arms provide full rear axle articulation.
- > Fitting the radius arms will contribute to a much better off-road capability for your vehicle by fully utilising your spring and shock absorber set.
- > Zinc passivated with a heavy-duty powder coating finish to complement each component.

DA5505	3° Heavy-duty	Narrow	Use with NTC7307 bush	38mm
DA5506	3° Heavy-duty	Wide	Use with NTC6781 bush	45mm
DA5510	2" Lift rear radius arm			



DA5510



See the end of this section for full details

SHOCK ABSORBERS - BRITPART CELLULAR DYNAMIC

including

BRITPART
CELLULAR
DYNAMIC



- > cellular technology tube
- > sintered 18mm rod
- > piston diameter 41mm
- > polyurethane bush
- > teflon piston with multi-lip seal
- > single piece eye ring



The Britpart Cellular Dynamic Shock Absorber represents a significant advance in Land Rover suspension systems. It features a cellular foam insert instead of a normal nitrogen gas or air, this is to stop the oil from boiling. The foam takes up less room which means more room for oil, 50% more, which offers maximum heat dispersion. This heat dispersion translates to a very subtle but controlled ride that will not fade no matter how hard you push them. They are ideal for a driver who needs more control to complement performance improvements or to enhance a standard vehicle.

The unique design ensures ride comfort and cornering ability is maximised and of course they are superb off-road.

2 year
WARRANTY
50,000
miles*

Note
*Terms & conditions apply
** Dimensions are +/- 5mm
*** The Plus 5" Cellular Dynamic Shock Absorbers are specialist suspension products and to install them additional fabrication work or brackets may be required. Please ensure that they are fitted by a competent expert.

Part Number	Application	Lift	Fitment	Open/Closed Dimensions**
DC6000	Defender/Discovery 1/Range Rover Classic		Front	600/380mm
DC6000L	Defender/Discovery 1/Range Rover Classic	50mm/2"	Front	665/425mm
DC6000LL	Defender/Discovery 1/Range Rover Classic	NEW 125mm/5" (see note***)	Front	765/455mm
DC6001	Defender/Discovery 1/Range Rover Classic		Rear	590/375mm
DC6001L	Defender/Discovery 1/Range Rover Classic	50mm/2"	Rear	625/385mm
DC6001LL	Defender/Discovery 1/Range Rover Classic	NEW 125mm/5" (see note***)	Rear	750/440mm
DC6010	Discovery 2		Front	590/370mm
DC6011	Discovery 2		Rear	585/365mm
DC6002	Range Rover P38 - air suspension		Front	560/365mm
DC6003	Range Rover P38 - air suspension		Rear	505/340mm
DC6004	Defender		Steering Damper	
DC6005	Discovery 1/Range Rover Classic/Series		Steering Damper	
DC6009	Discovery 2		Steering Damper	
DC6006	Range Rover P38		Steering Damper	



SHOCK ABSORBERS - BRITPART SUPER GAZ

Super Gaz Shock Absorbers



Part Number	Application	Lift	Fitment	Open/Closed Dimensions**
DC5002	Defender/Discovery 1/Range Rover Classic		Front	605/385mm
DC5002L	Defender/Discovery 1/Range Rover Classic	50mm/2"	Front	655/405mm
DC5003	Defender/Discovery 1/Range Rover Classic		Rear	590/375mm
DC5003L	Defender/Discovery 1/Range Rover Classic	50mm/2"	Rear	640/400mm
DC5000	Discovery 2		Front	590/370mm
DC5000L NEW	Discovery 2	50mm/2"	Front	640/400mm
DC5001	Discovery 2		Rear	585/365mm
DC5001L NEW	Discovery 2	50mm/2"	Rear	635/390mm
DC5004	Defender		Steering damper	
DC5005	Discovery 1/Range Rover Classic/Series		Steering damper	

24 month / 50,000 mile Warranty*

*Super Gaz Shock Absorbers
Terms and conditions apply

** +/- 5mm

Britpart Super Gaz Shock Absorbers offer a 35mm bore tube filled with Fuchs shock absorber fluid, using the best seal available, single piece eye rings, polyurethane bush mounts and a very durable powder coated finish. These offer a vast improvement in ride quality and damping performance. They are ideal for use with either of the Britpart Yellow Spring range or standard Land Rover Springs. Please ask for a CD of the shock absorbers in use or see the suspension section on the Britpart website!



SHOCK ABSORBER BRACKETS NEW



DA6323L

Any extreme force encountered is divided between the two shock absorbers for a more comfortable ride for you and your passengers.



DA6322



DA6322L



DA6323



Kit includes nuts, bolts & washers

DA6324

Sometimes off-road conditions can be serious enough to test the standard equipment on your Land Rover to its maximum. One of the critical components that takes most of the abuse is the suspension system. When using the standard single shock absorber configuration it is not unknown for the shock absorber to break the factory fitted turret mount. These new shock absorber brackets from Britpart give you confidence that your vehicles suspension will tackle the terrain you take it through with greater ease.

The single shock absorber bracket is manufactured from heavy-duty steel and replaces the existing turret mount which is susceptible to corrosion by allowing a build up of dirt inside which is hard to clean thoroughly. The new design is harder wearing and easier to clean.

The twin shock absorber bracket is manufactured from the same quality steel as the single shock absorber bracket but allows for the fitment of an additional shock absorber. The benefits of having extra shock absorbers fitted to your Land Rover is that any extreme force encountered is divided between the two shock absorbers for a more comfortable ride for you and your passengers. Using twin shocks is also beneficial when carrying loads both on and off-road as it improves the load carrying ability of the vehicle. An additional benefit is that when changing shock absorbers there is no need to remove the brackets. **Note** - rear brackets involve some welding to fit.

DA6322	Defender/Discovery 1/Range Rover Classic	Twin shock brackets	Front	Standard height
DA6322L	Defender/Discovery 1/Range Rover Classic	Twin shock brackets	Front	2" Lift
DA6323	Defender/Discovery 1/Range Rover Classic	Single shock brackets	Front	Standard height
DA6323L	Defender/Discovery 1/Range Rover Classic	Single shock brackets	Front	2" Lift
DA6324	Defender/Discovery 1/Range Rover Classic	Twin shock brackets - kit	Rear	
DA6324A	Defender/Discovery 1/Range Rover Classic	Lower twin shock brackets - axle	Rear	



Picture courtesy of Kristjan Kristjansson

SHOCK ABSORBERS - DELPHI DE CARBON

Shock Absorbers

DA4162	Series LWB/SWB	Front
DA4163	Series SWB	Rear
DA4164	Series LWB	Rear
DA4090	Range Rover Classic/Defender to 1999/Discovery to 1994 including air suspension	Front
DA4091	Range Rover Classic/Defender to 1999/Discovery to 1994 including air suspension	Rear
DA4092	Discovery - 1994 - 1999	Rear
DA4181	Range Rover Classic/Defender to 1999/Discovery to 1994	Front +2"
DA4182	Range Rover Classic/Defender to 1999/Discovery to 1994	Rear +2"

Note - Boxed as a pair, priced individually

Steering Dampers

DA4160	Series/Range Rover Classic/Discovery to 1998
DA4161	Defender

